

Zallys®

• • • the passion for moving

K4

Z184.720



12,0 km/h



1.500 kg



2,80 m



- Per carichi fino a 2.500 kg.
- Versatile e compatto.
- Con ruote antitraccia per uso interno.
- Con rallentatore di velocità in sterzata.
- Tasto per regolazione a 5 velocità di marcia.
- Vasta gamma di ganci standard o personalizzabili su richiesta.



Scansiona questo QR code
per maggiori informazioni

ZALLYs srl
Via Palazzina 1 | 36030 Sarcedo (VI) - ITALY
www.zallys.com | sales@zallys.com

K4

Zallys®

... the passion for moving



MANUTENZIONI INDUSTRIALI



INDUSTRIA CHIMICA



☐☐☐ → **LINEE PRODUTTIVE**



 **SUPERMERCATI & GDO**



Scansiona questo QR code
per vedere tutte le applicazioni

ZALLYS srl
Via Palazzina 1 | 36030 Sarcedo (VI) - ITALY
www.zallys.com | sales@zallys.com

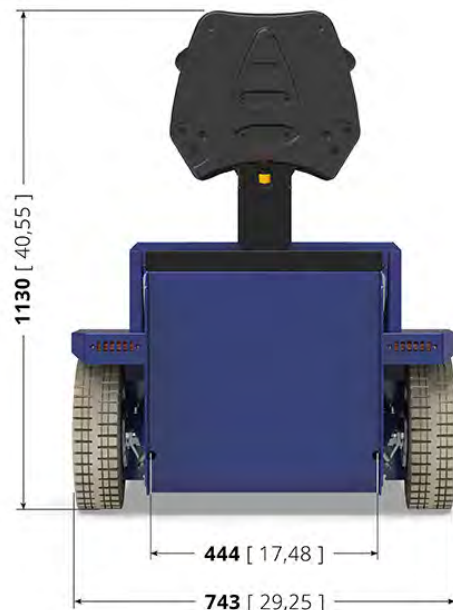
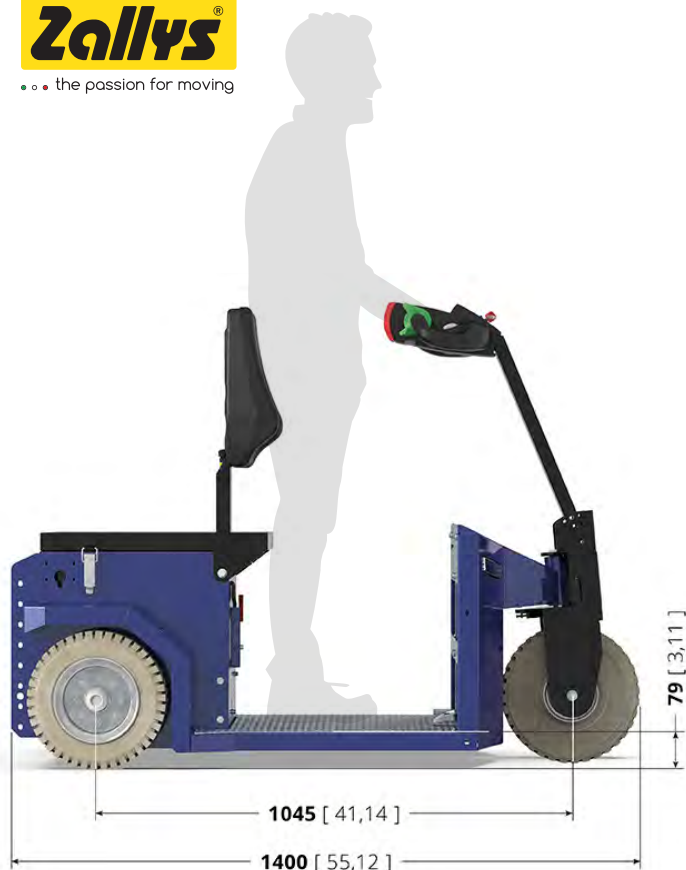

DATI TECNICI

Comandi guida

Descrizione	U.M.	Valore
Tipologia di guida		Timone

Sicurezza

Descrizione	U.M.	Valore
Dispositivo antischiacciamento		Pulsante su timone
Dispositivo per arresto emergenza		Presca con maniglia

Prestazioni

Descrizione	U.M.	Valore
Velocità massima marcia avanti	km/h	12,0
Velocità massima marcia indietro	km/h	12,0
Forza massima di trazione al gancio	N	1.500
Traino massimo su piano *	kg	2.500
Spazio d'arresto in decelerazione (senza carico)	m	1,80

Batterie

Descrizione	U.M.	Valore
Tipologia batterie		Trazione - Ermetiche a AGM
Tensione batteria	V	12
Capacità nominale 20/h	Ah	130
Carica batterie		Esterno - ad alta frequenza

Motore

Descrizione	U.M.	Valore
Motore		Elettrico
Corrente		Continua
Tensione	V	24
Potenza nominale (S2 - 10')	kW	1,50
Potenza massima di picco	kW	1,50

Dimensioni e pesi

Descrizione	U.M.	Valore
Peso proprio con batterie	kg	234
Lunghezza	mm	1.400
Larghezza	mm	743
Altezza	mm	1.130
Interasse ruote	mm	1.045
Diametro di sterzata	m	2,80

Ruote

Descrizione	U.M.	Valore
Gommatura		Superelastica Antitraccia

* Fermo restando invariata la forza al gancio espressa in N, la capacità di traino espressa in kg può variare in base a: pendenza e tipologia di terreno sul quale viene effettuato il traino, utilizzo o meno di zavorre e tipo di ruote montate su macchina e rimorchio.



Scansiona questo QR code
per maggiori dati tecnici

ACCESSORI



LUCE BLU DI
SEGNALAZIONE



KIT CARTER
PROTEZIONE



KIT PARAURTI
ANTERIORE

Prestazioni di traino

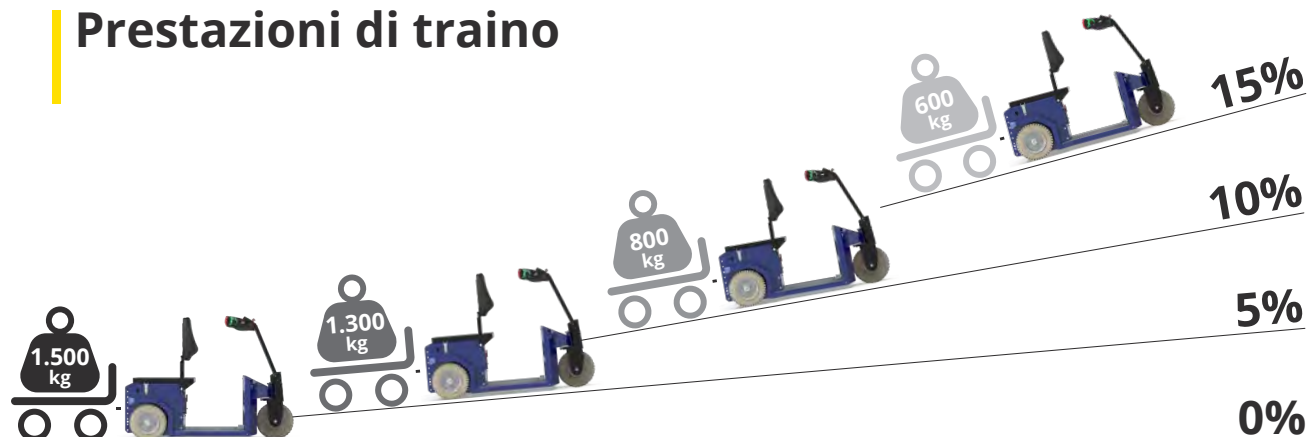

Scansiona questo QR code
per vedere tutti gli accessori



the passion for moving

K4

Z184.720



12,0 km/h



1.500 kg



2,80 m



- For loads up to 2.500 kg.
- Versatile and compact.
- Non-marking wheels for indoor use.
- Optional steering speed reduction.
- 5-levels speed adjustment.
- Wide range of accessories and connections.



Scan this QR code
for more information

ZALLYs srl

Via Palazzina 1 | 36030 Sarcedo (VI) - ITALY
www.zallys.com | sales@zallys.com

K2



INDUSTRIAL MAINTENANCE



CHEMICAL INDUSTRY



PRODUCTION LINES



SUPERMARKETS & LARGE DISTRIBUTION



Scan this QR code
to see all applications

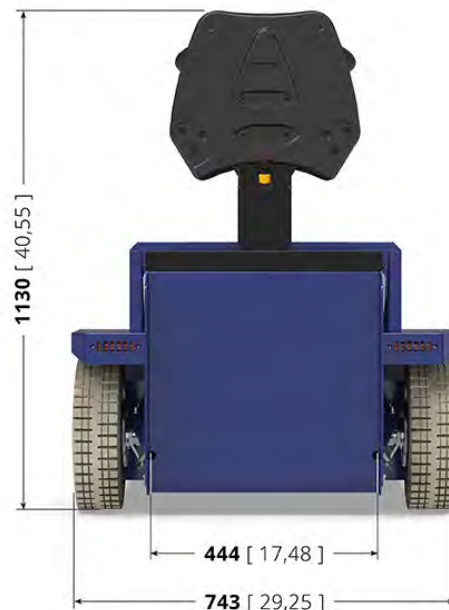
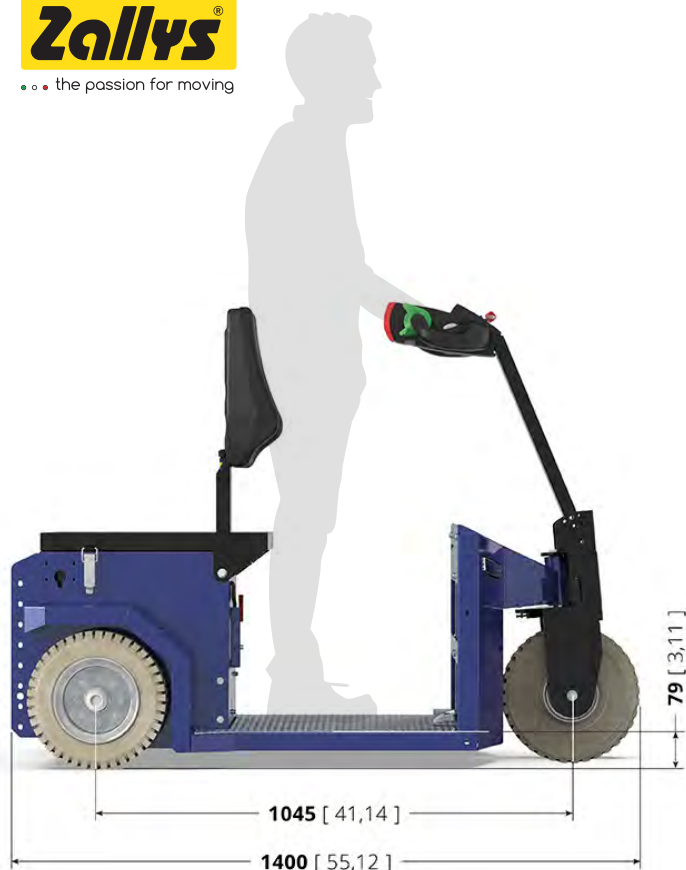

TECHNICAL DATA

Drive controls

Description	U.M.	Value
Type of control		Tillerhead

Safety

Description	U.M.	Value
Emergency reverse button		On tiller head
Power Emergency stop		Detachable power connector

Performances

Description	U.M.	Value
Max. forward speed	km/h	12,0
Max. backward speed	km/h	12,0
Max.towing capacity on flat ground	N	1.500
Max towing force at hook *	kg	2.500
Stopping distance in deceleration (without load)	m	1,80

Battery

Description	U.M.	Value
Batteries type		Traction AGM batteries
Battery voltage	V	12
Nominal Capacity 20 h	Ah	130
Battery charger		External - high frequency

Motor

Description	U.M.	Value
Engine		Electric
Electricity		Direct
Engine voltage	V	24
Rating (S2 - 10')	kW	1,50
Maximum peak power	kW	1,50

Dimensions and Weight

Description	U.M.	Value
Weight incl. with batteries	kg	234
Length	mm	1.400
Width	mm	743
Height	mm	1.130
Wheelbase	mm	1.045
Turning circle	m	2.80

Wheels

Description	U.M.	Value
Tyres		Super-elastic non-marking

* Without changing the hook force expressed in N, the towing capacity expressed in kg may vary according to: slope and type of terrain on which towing is carried out, use or not of ballasts and type of wheels mounted on the machine and trailer.



Scan this QR code
for more technical data

ACCESSORIES



BLUE
WARNING LIGHT



WHEELS
PROTECTION KIT



FRONT BUMPER

Performances on slopes

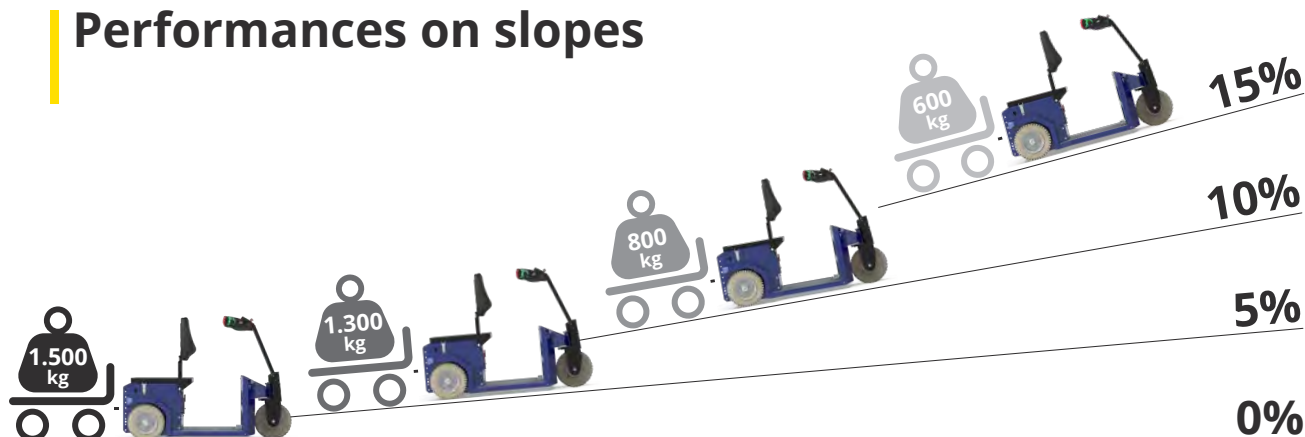

Scan this QR code
to see all accessories

Zallys®

• • • the passion for moving

K4

Z184.720



12,0 km/h



1.500 kg



2,80 m



- Pour des charges jusqu'à 2.500 kg.
- Polyvalent et compact.
- Avec roues non marquantes pour une utilisation en intérieur.
- Avec ralentisseur de direction en option.
- Bouton pour le réglage à 5 vitesses.
- Large gamme de crochets standard ou personnalisables sur demande.



QR code à scanner
Informations complémentaires

ZALLYs srl
Via Palazzina 1 | 36030 Sarcedo (VI) - ITALY
www.zallys.com | sales@zallys.com



MAINTENANCE INDUSTRIELLE



INDUSTRIE CHIMIQUE



LIGNES DE PRODUCTION



LOGISTIQUE INTÉGRÉE ET CHAÎNES DE MAGASINS



QR code à scanner
Voir toutes les applications

ZALLYS srl
Via Palazzina 1 | 36030 Sarcedo (VI) - ITALY
www.zallys.com | sales@zallys.com

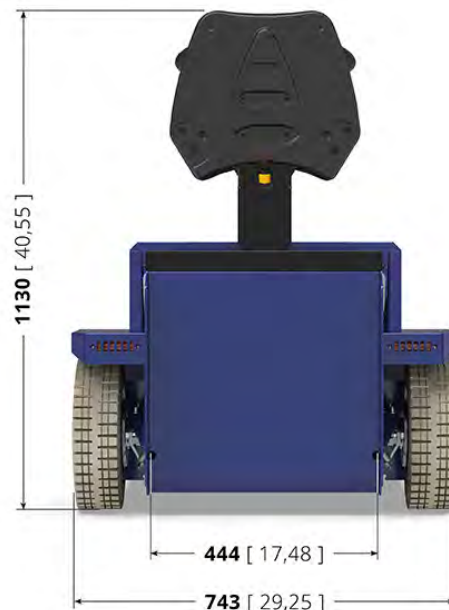
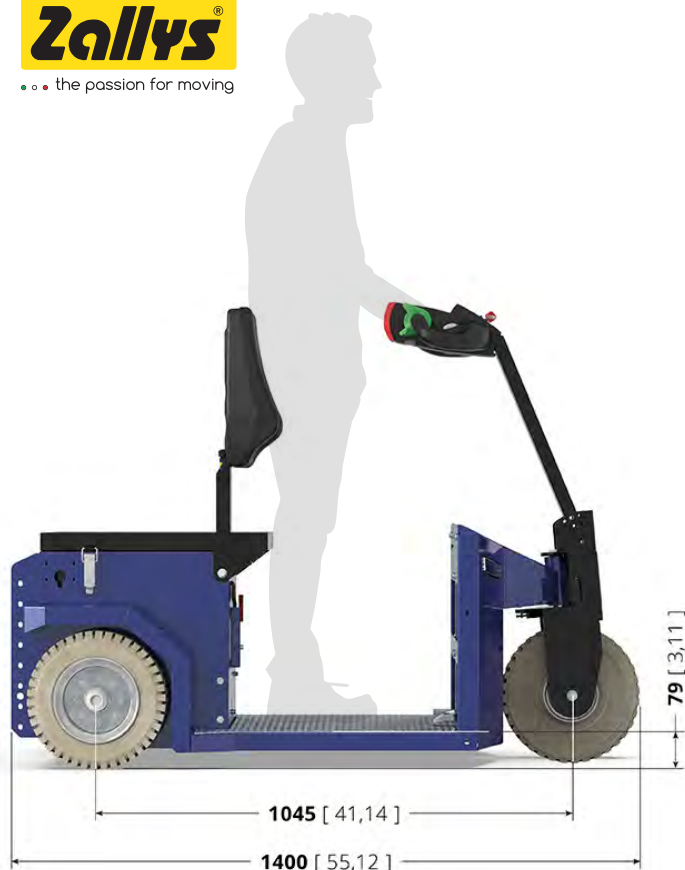

FICHE TECHNIQUE

Commandes de conduite

Description	U.M.	Valeur
Type de conduite		Timon

Sécurité

Description	U.M.	Valeur
Dispositif anti-écrasement		Bouton sur timon
Dispositif arrêt d'urgence		Poignée

Performances

Description	U.M.	Valeur
Vitesse max. marche avant	km/h	12,0
Vitesse max. marche arrière	km/h	12,0
Effort de traction max au crochet	N	1.500
Capacité de traction max.*	kg	2.500
Espace d'arrêt de vitesse max sur sol plan (sans charge)	m	1,80

Batteries

Description	U.M.	Valeur
Type Batteries		Traction - Ermetique à AGM
Tension batterie	V	12
Capacité nominale 20/h	Ah	130
Chargeur Batteries		Extérieure - haute fréquence

Moteur

Description	U.M.	Valeur
Moteur		Electrique
Courant		Continu
Tension	V	24
Puissance nominale (S2 - 10')	kW	1,50
Puissance maximale	kW	1,50

Dimensions et poids

Description	U.M.	Valeur
Poids avec Batteries	kg	234
Longueur	mm	1.400
Largeur	mm	743
Hauteur	mm	1.130
Empattement	mm	1.045
Rayon de braquage	m	2.80

Roues

Description	U.M.	Valeur
Gommées		Super élastique anti-trace

* Les circonstances suivantes peuvent modifier la capacité de traction en kg de la machine (la force indiquée en N reste inchangée): type de terrain sur lequel la traction est effectuée, machine lestée ou pas lestée, type des roues montées sur la machine et la remorque.



QR code à scanner
Pour plus de détails techniques

ACCESSOIRES



PHARE BLEU
D'AVERTISSEMENT



KIT DE PROTECTION
DES ROUES



PARE-CHOC
AVANT

Performances de traction

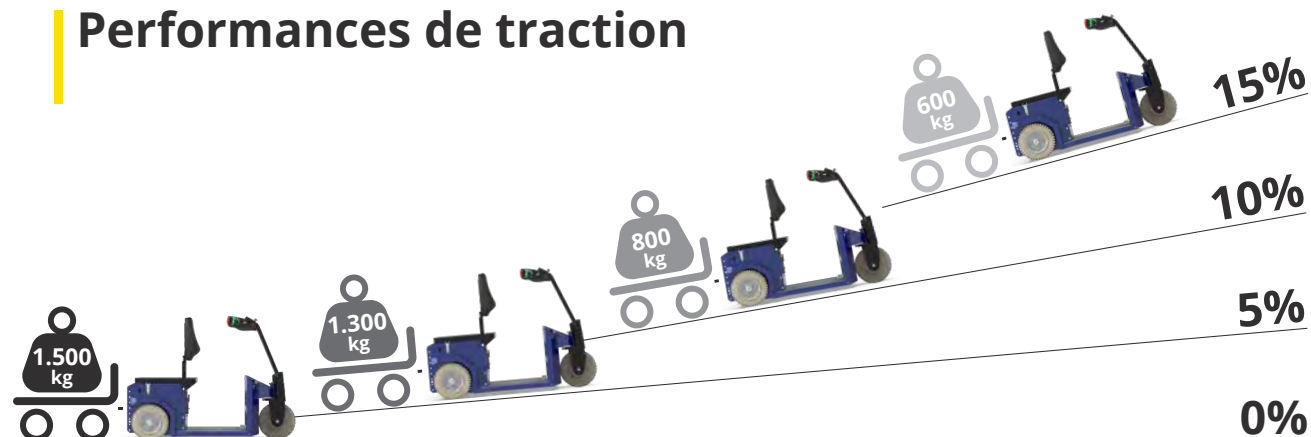

QR code à scanner
Voir tous les accessoires

Zallys®

• • • the passion for moving

K4

Z184.720



12,0 km/h



1.500 kg



2,80 m



- Para cargas de hasta 2.500 kg.
- Versátil y compacto.
- Con ruedas que no dejan marcas para uso interno.
- Con retardador de velocidad de dirección opcional.
- Selector de velocidad de 5 niveles.
- Amplia gama de ganchos estándar o personalizables bajo pedido.



Escanea este código QR
para más información

ZALLYS srl
Via Palazzina 1 | 36030 Sarcedo (VI) - ITALY
www.zallys.com | sales@zallys.com



MANTENIMIENTO INDUSTRIAL



INDUSTRIA QUÍMICA



LÍNEAS DE PRODUCCIÓN



SUPERMERCADOS Y GDO



Escanea este código QR
para ver todas las aplicaciones

ZALLYS srl
Via Palazzina 1 | 36030 Sarcedo (VI) - ITALY
www.zallys.com | sales@zallys.com

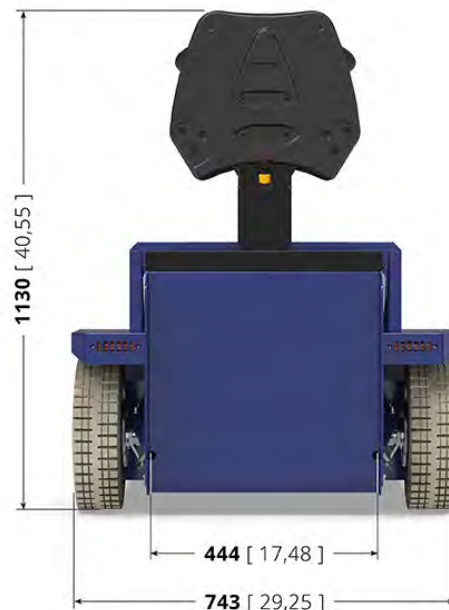
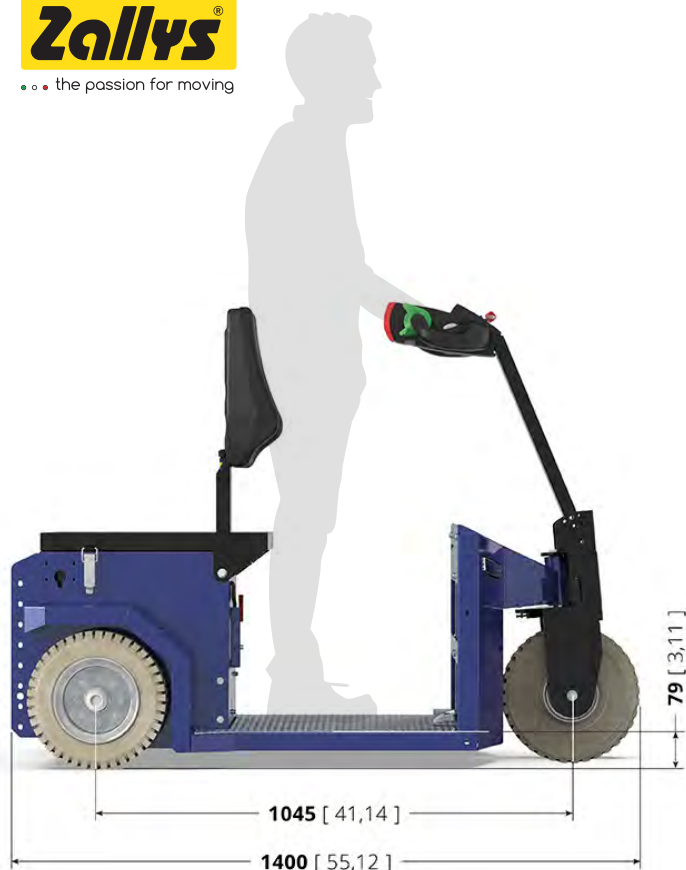

DATOS TÉCNICOS

Tipo de mando

Descripción	U.M.	Valor
Conducción		Timones

Seguridad

Descripción	U.M.	Valor
Dispositivo anti-aplastamiento		Integrado en el timón
Dispositivo de parada de emergencia		Conector de alimentación desmontable

Prestaciones

Descripción	U.M.	Valor
Velocidad max. marcha adelante	km/h	12,0
Velocidad max. de marcha atrás	km/h	12,0
Fuerza de tracción máx al gancho	N	1.500
Capacidad de tracción max.en plano*	kg	2.500
Espacio de parada en desaceleración (sin carga)	m	1,80

Baterías

Descripción	U.M.	Valor
Tipo de baterías		Baterías de tracción de AGM
Tensión de la batería	V	12
Capacidad nominal 20 h	Ah	130
Cargador de baterías		Externo - en alta frecuencia

Motor

Descripción	U.M.	Valor
Motor		Eléctrico
Electricidad		Continua
Motor	V	24
Potencia (S2 - 10')	kW	1,50
Pico de potencia máxima	kW	1,50

Medidas y Pesos

Descripción	U.M.	Valor
Peso incl.baterías	kg	234
Longitud	mm	1.400
Anchura	mm	743
Altura	mm	1.130
Distancia de ejes	mm	1.045
Radio de giro	m	2.80

Ruedas

Descripción	U.M.	Valor
Bandajes		Superelástica antihuellas

* Sin modificar la fuerza del gancho expresada en N, la capacidad de remolque expresada en kg puede variar según: pendiente y tipo de terreno sobre el que se realiza el arrastre, uso o no de contrapesos y tipo de ruedas montadas en la máquina y remolque.



Escanea este código QR para más datos técnicos

ACCESORIOS



LUZ DE ADVERTENCIA
AZUL



KIT PROTECCIÓN DE
LAS RUEDAS



PARAQUOQUES
DELANTERO

Rendimiento en pendiente

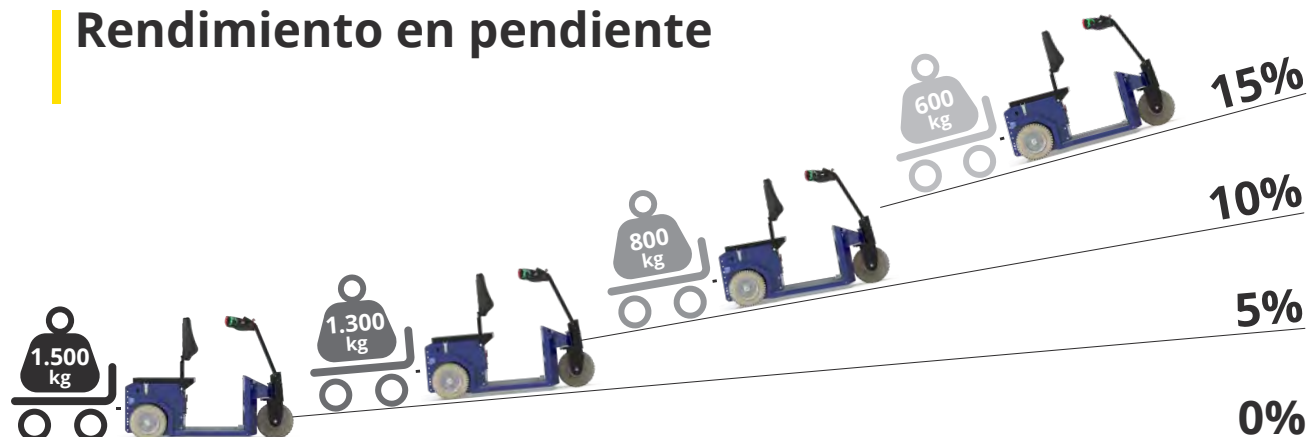

Escanea este código QR
para ver todos los accesorios

Zallys®

• • • the passion for moving

K4

Z184.720



12,0 km/h



1.500 kg



2,80 m



- Für Lasten bis 2.500 kg.
- Vielseitig und kompakt.
- Mit Anti-Spur-Räder für den Innenbereich.
- Mit optionalem Lenkgeschwindigkeitsverzögerer.
- Taste zur 5-Gang-Einstellung.
- Große Auswahl an Standard- oder anpassbaren Haken auf Anfrage.



Scannen Sie diesen QR-Code
für weitere Informationen

ZALLYS srl
Via Palazzina 1 | 36030 Sarcedo (VI) - ITALY
www.zallys.com | sales@zallys.com



INDUSTRIELLE INSTANDHALTUNG



CHEMISCHE INDUSTRIE



PRODUKTIONSLINIEN



SUPERMERCATI & GDO



Scannen Sie diesen QR-Code
um alle Anwendungen zu sehen

ZALLYS srl
Via Palazzina 1 | 36030 Sarcedo (VI) - ITALY
www.zallys.com | sales@zallys.com

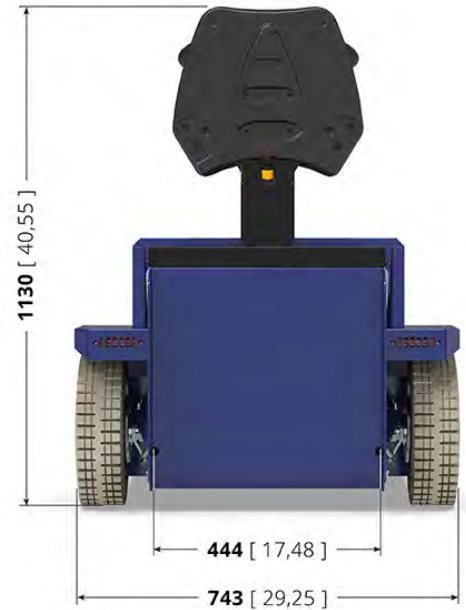
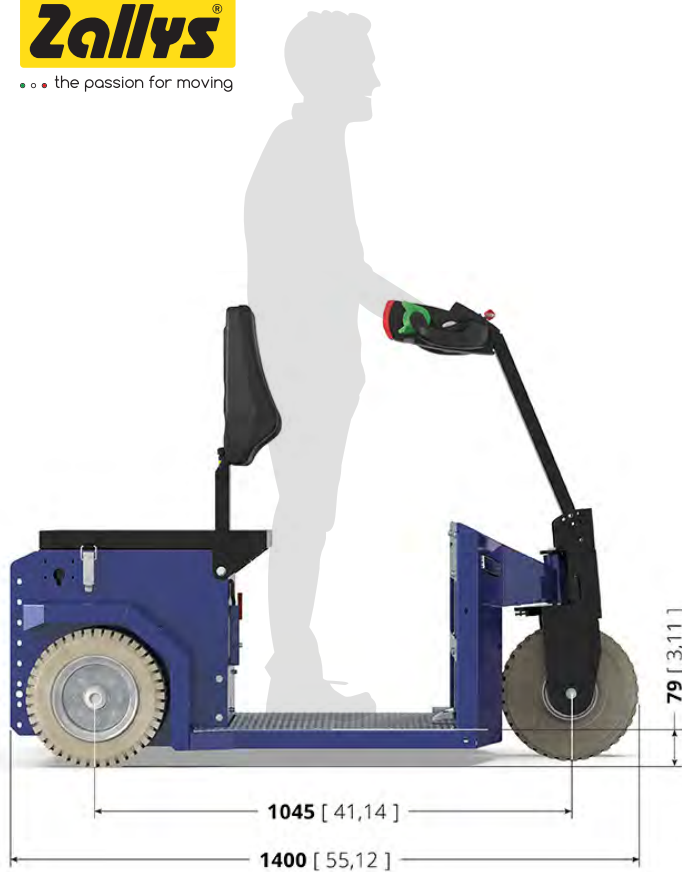

TECHNISCHE DATEN

Lenksysteme

Beschreibung	U.M.	Wert
Art der Anleitung		Deichsel

Sicherheit

Beschreibung	U.M.	Wert
Anti-Zerquetschvorrichtung		Knopf auf Deichsel
Not-Halt-Einrichtung		Lenker Handprotectoren

Leistung

Beschreibung	U.M.	Wert
Max. Fahrgeschwindigkeit	km/h	12,0
Max. Fahrgeschwindigkeit Rückwärts	km/h	12,0
Maximale Tragfähigkeit auf der Ebene	N	1.500
Maximale Zugkraft am Haken*	kg	2.500
Bremsbereich bei Verzögerung (ohne Ladung)	m	1,80

Batterien

Beschreibung	U.M.	Wert
Batterietypologie		Traktion – Hermetische AGM
Batteriespannung	V	12
Nennkapazität 20/h	Ah	130
Ladegerät		Extern – Hochfrequenz

Motor

Beschreibung	U.M.	Wert
Motor		Elektrisch
Strom		Durchgehend
Spannung	V	24
Nennleistung (S2 - 10')	kW	1,50
Maximale Spitzenleistung	kW	1,50

Dimensionen und Gewicht

Beschreibung	U.M.	Wert
Gewicht mit Batterien	kg	234
Länge	mm	1.400
Breite	mm	743
Höhe	mm	1.130
Achsabstand Räder	mm	1.045
Lenkdurchmesser	m	2.80

Räder

Beschreibung	U.M.	Wert
Gummierung		Superelastische Antispur

* Bei unveränderter Hakenkraft in N kann die Zugkraft in kg je nach Neigung und Art des Geländes, auf dem gezogen wird, Verwendung oder Nichtnutzung von Ballast und Art der Räder an der Maschine und dem Anhänger variieren.



Scannen Sie diesen QR-Code für mehrere technische daten

ZUBEHÖRTEILE



BLAUES
WARNLICHT



RÄDERSCHUTZ-KIT



FRONTSTOSSSTANGE

Schlepplleistung

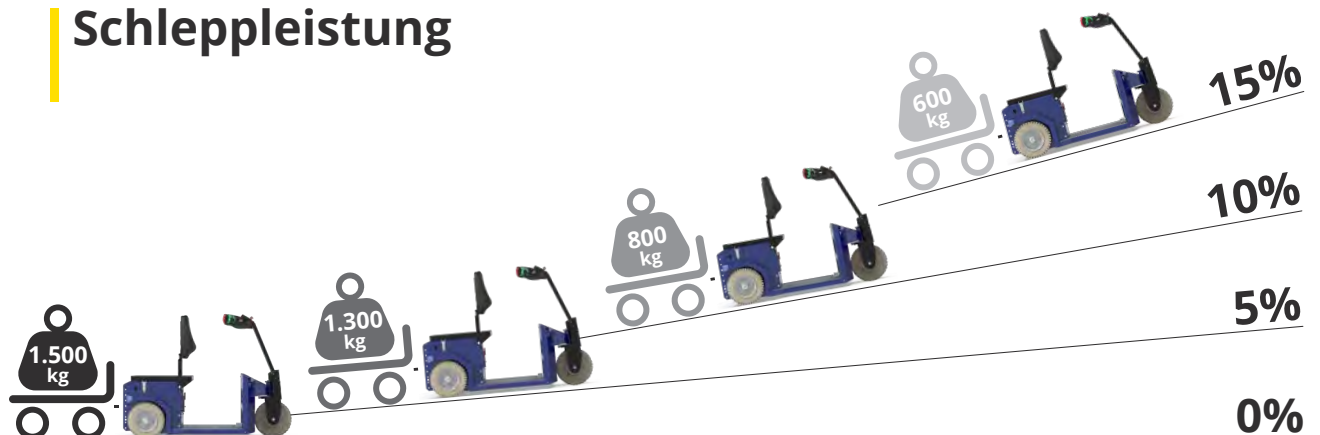

Scannen Sie diesen QR-Code
um alle Zubehörteile zu sehen