

Zallys®

• • • the passion for moving

S1

Z111.732



12,0 km/h 500 kg 1.500 kg



- Versatile e compatto.
- Per trainare carichi fino a 1.500 kg e trasportare fino a 500 kg.
- Ristretto raggio di sterzata.
- Con ruote pneumatiche per uso interno ed esterno.
- Tasto per regolazione velocità.
- Vasta gamma di accessori standard o personalizzabili su richiesta.



Scansiona questo QR code
per maggiori informazioni

ZALLYs srl
Via Palazzina 1 | 36030 Sarcedo (VI) - ITALY
www.zallys.com | sales@zallys.com



MANUTENZIONE INDUSTRIALE



MANUTENZIONE DEL VERDE



Scansiona questo QR code
per vedere tutte le applicazioni

ZALLYS srl
Via Palazzina 1 | 36030 Sarcedo (VI) - ITALY
www.zallys.com | sales@zallys.com

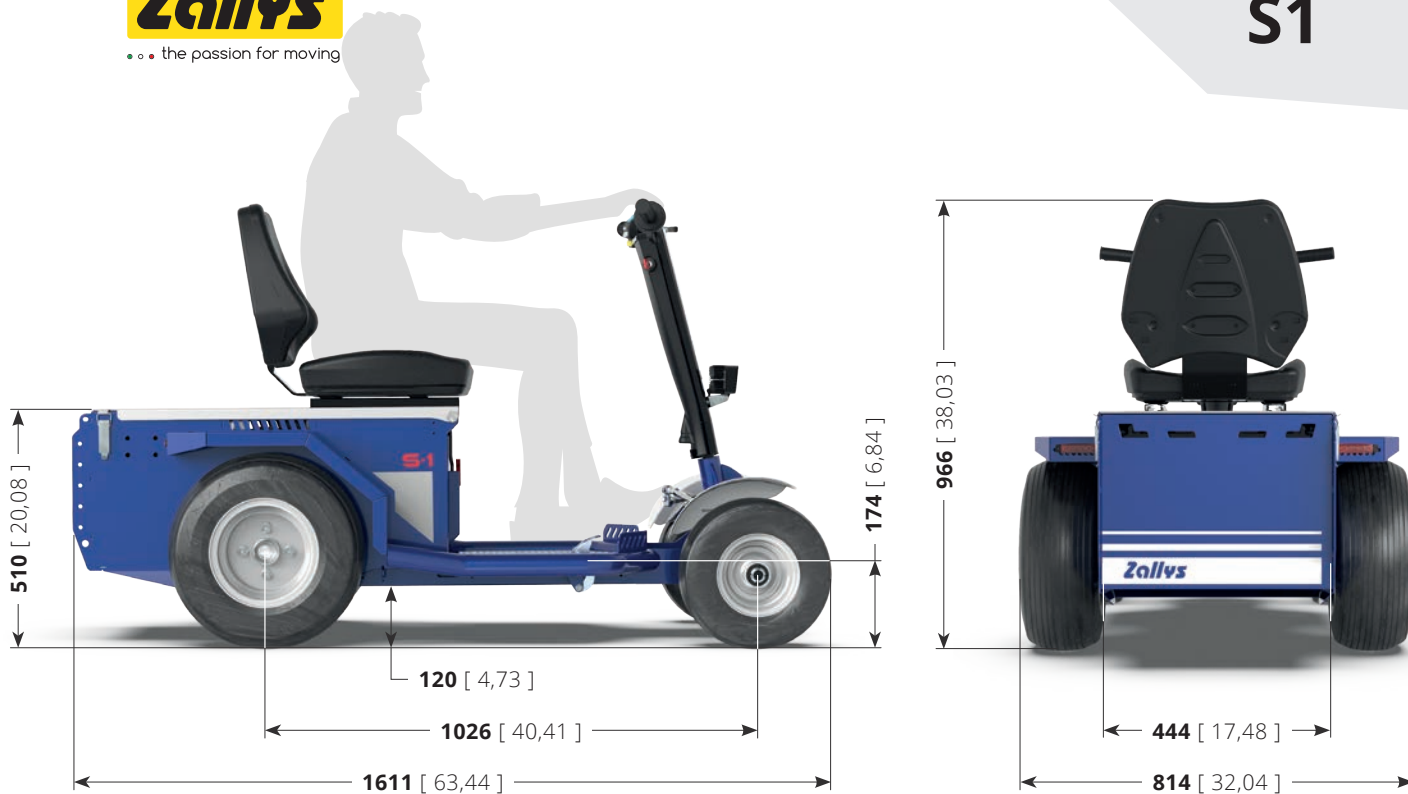

DATI TECNICI

Comandi guida

Descrizione	U.M.	Valore
Tipologia di guida		Manubrio

Sicurezza

Descrizione	U.M.	Valore
Dispositivo uomo-presente		Micro su sedile
Dispositivo per arresto di emergenza		Presa con maniglia

Prestazioni

Descrizione	U.M.	Valore	Con Upgrade
Velocità massima marcia avanti	km/h	10,0	12,0
Velocità massima marcia indietro	km/h	8,0	10,0
Portata massima su piano	kg	500	
Pendenza massima	%	15	
Forza massima di trazione al gancio*	N	500	1.500
Spazio d'arresto in decelerazione (senza carico)	m	6	

Batterie

Descrizione	U.M.	Valore
Tipologia batterie		Trazione - Ermetiche a AGM
Tensione batteria	V	12
Capacità nominale 20/h	Ah	130
Carica batterie		Esterno - ad alta frequenza

Motore

Descrizione	U.M.	Valore
Motore		Elettrico
Corrente		Continua
Tensione	V	24
Potenza nominale (S2 - 5')	kW	1
Potenza massima di picco	kW	2,20

Dimensioni e pesi

Descrizione	U.M.	Valore
Peso proprio con batterie	kg	211
Lunghezza	mm	1.611
Larghezza	mm	814
Altezza	mm	966
Altezza piano di carico	mm	510
Interasse ruote	mm	1.026
Diametro di sterzata	mm	3.600

Ruote

Descrizione	U.M.	Valore
Gommatura		Pneumatica
Gommatura opzionali		Superelastica Antiraccia

* Fermo restando invariata la forza al gancio espressa in N, la capacità di traino espressa in kg può variare in a base a: pendenza e tipologia di terreno sul quale viene effettuato il traino, utilizzo o meno di zavorre e tipo di ruote montate su macchina e rimorchio.



Scansiona questo QR code
per maggiori dati tecnici

GANCI STANDARD & ACCESSORI

Connessioni per tutte le esigenze



GANCIO CON SFERA-PERNO



GANCIO CON SPINA

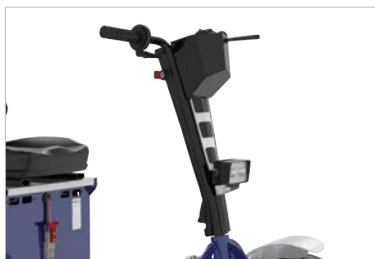

PORTA OGGETTI PER MANUBRI



CESTO



LUCI LED ANTERIORI E POSTERIORI

VISIBILITÀ IN OGNI TIPO DI AMBIENTE

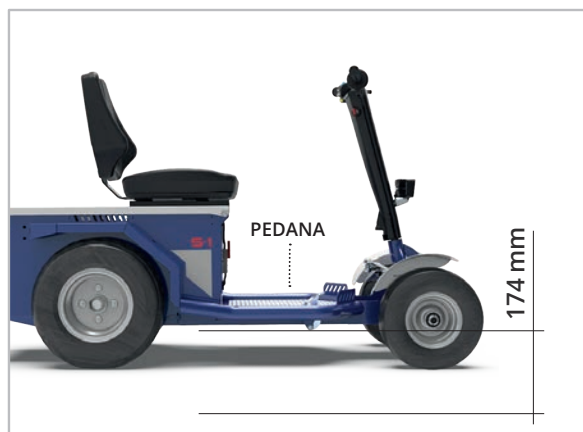

PEDANA

174 mm

MASSIMA AGILITÀ PER UN UTILIZZO PIÙ EFFICIENTE

Prestazioni di traino

-  = Versione standard
-  = Con Upgrade

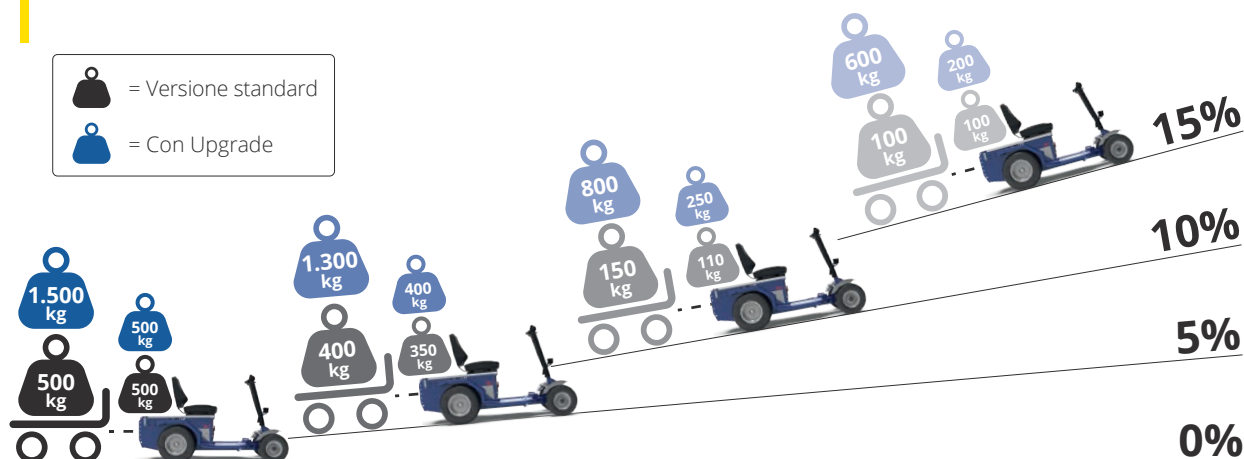

Scansiona questo QR code per vedere tutti gli accessori

Zallys®

• • • the passion for moving

S1

Z111.732



12,0 km/h 500 kg 1.500 kg



- Can tow loads up to 1.500 kg and load up to 500 kg.
- Versatile and compact.
- Short steering radius.
- Pneumatic wheels for both indoor and outdoor use.
- 5-levels speed adjustment.
- Wide range of accessories and connections.



Scan this QR code
for more information

ZALLYS srl
Via Palazzina 1 | 36030 Sarcedo (VI) - ITALY
www.zallys.com | sales@zallys.com



INDUSTRIAL MAINTENANCE



GREEN MAINTENANCE



Scan this QR code
to see all applications

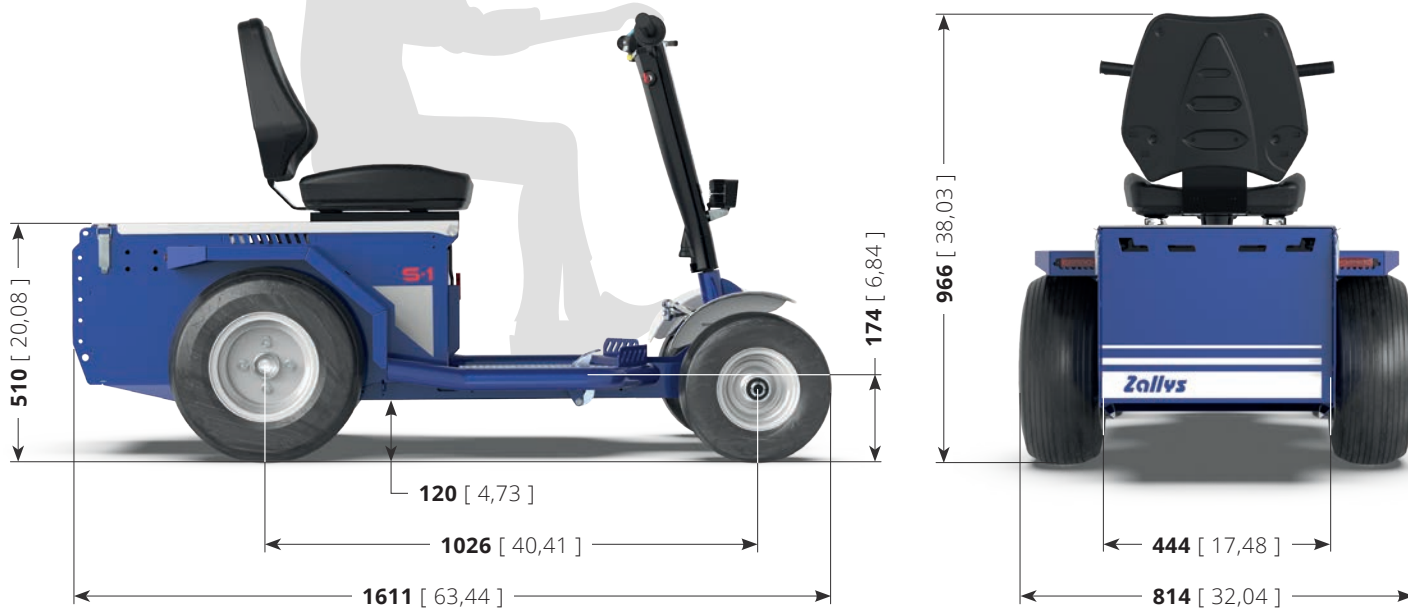

TECHNICAL DATA

Drive controls

Description	U.M.	Value
Type of control		Handle Bars

Safety

Description	U.M.	Value
Dead man safety system		Seat presence sensor
Power Emergency stop		Detachable power connector

Performances

Description	U.M.	Value	With Upgrade
Max. forward speed	km/h	10,0	12,0
Max. backward speed	km/h	8,0	10,0
Max.load capacity on flat ground	kg	500	
Max.slope with load	%	15	
Max. towing capacity on wheels*	N	500	1.500
Stopping distance in deceleration (without load)	m	6	

Battery

Description	U.M.	Value
Batteries type		Traction AGM batteries
Battery voltage	V	12
Nominal Capacity 20 h	Ah	130
Battery charger		External - high frequency

Motor

Description	U.M.	Value
Engine		Electric
Electricity		Direct
Engine voltage	V	24
Rating (S2 - 5')	kW	1
Maximum peak power	kW	2,20

Dimensions and Weight

Description	U.M.	Value
Weight incl. with batteries	kg	211
Length	mm	1.611
Width	mm	814
Height	mm	966
Loading platform height	mm	510
Wheelbase	mm	1.026
Turning circle	mm	3.600

Wheels

Description	U.M.	Value
Tyres		Pneumatic
Optional tyres		Super-elastic non-marking

* Without changing the hook force expressed in N, the towing capacity expressed in kg may vary according to: slope and type of terrain on which towing is carried out, use or not of ballasts and type of wheels mounted on the machine and trailer.



Scan this QR code
for more technical data

STANDARD HITCH AND ACCESSORIES

Connections for all needs



BALL/PIN HITCH



DROP PIN HITCH



HANDLEBAR BASKET



BASKET



FRONT AND REAR LED LIGHTS

VISIBILITY IN EVERY WORK ENVIRONMENT

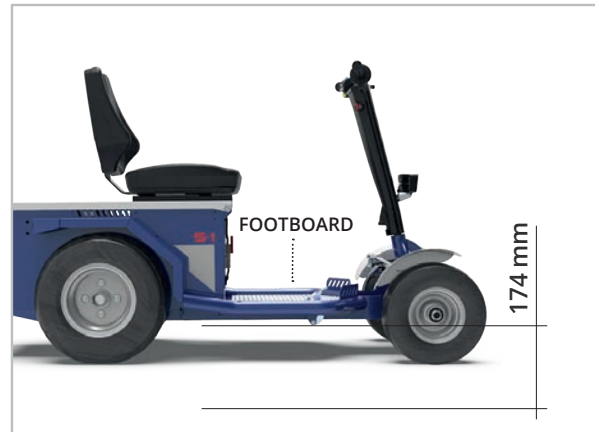



FOOTBOARD

174 mm

MAXIMUM AGILITY FOR A MORE EFFICIENT USE

Performances on slopes

-  = Standard version
-  = With Upgrade

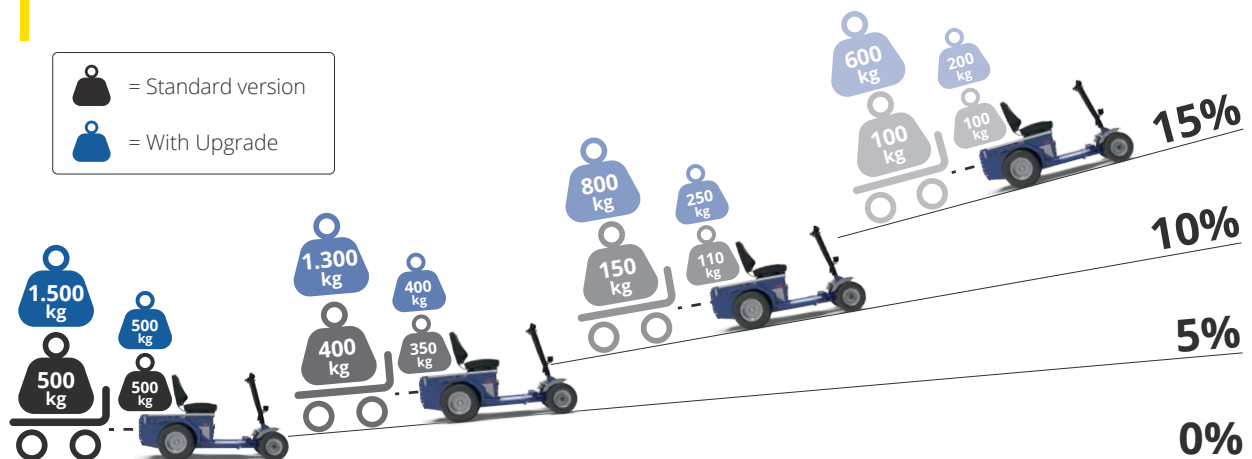

Scan this QR code to see all accessories

Zallys®

• • • the passion for moving

S1

Z111.732



12,0 km/h 500 kg 1.500 kg



- Pour tracter jusqu'à 1.500 kg et charger jusqu'à 500kg.
- Polyvalent et compact.
- Ayon de braquage étroit.
- Avec roues pneumatiques pour une utilisation intérieure et extérieure.
- Bouton en option pour le réglage vitesses.
- Large gamme d'accessoires standard ou personnalisable sur demande.



QR code à scanner
Informations complémentaires

ZALLYs srl
Via Palazzina 1 | 36030 Sarcedo (VI) - ITALY
www.zallys.com | sales@zallys.com



MAINTENANCE INDUSTRIELLE



ENTRETIEN ESPACE VERTS



QR code à scanner
Voir toutes les applications

ZALLYS srl
Via Palazzina 1 | 36030 Sarcedo (VI) - ITALY
www.zallys.com | sales@zallys.com

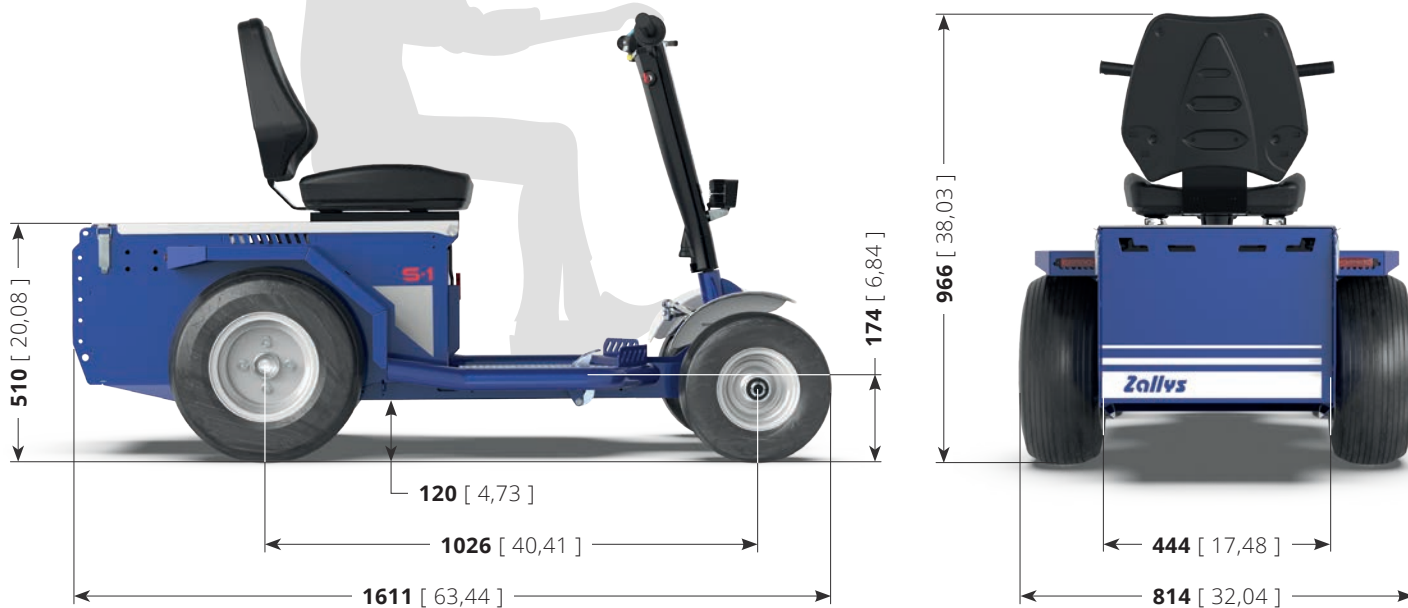

FICHE TECHNIQUE

Commandes de conduite

Description	U.M.	Valeur
Type de conduite		Timon

Sécurité

Description	U.M.	Valeur
Dispositif "homme-mort"		Micro sur assise
Dispositif arrêt d'urgence		Poignée

Performances

Description	U.M.	Valeur	Avec Upgrade
Vitesse max. marche avant	km/h	10,0	12,0
Vitesse max. marche arrière	km/h	8,0	10,0
Charge max. sur terrain plat	kg	500	
Pente max	%	15	
Effort de traction max au crochet*	N	500	1.500
Espace d'arrêt de vitesse max sur sol plan (sans charge)	m	6	

Batteries

Description	U.M.	Valeur
Type de Batteries		Traction - Ermetique à AGM
Tension batterie	V	12
Capacité nominale 20/h	Ah	130
Chargeur Batteries		Extérieure - haute fréquence

Moteur

Description	U.M.	Valeur
Moteur		Electrique
Courant		Continu
Tension	V	24
Puissance nominale (S2 - 5')	kW	1
Puissance maximale	kW	2,20

Dimensions et poids

Description	U.M.	Valeur
Poids avec batteries	kg	211
Longueur	mm	1.611
Largeur	mm	814
Hauteur	mm	966
Hauteur plateau de charge	mm	510
Empattement	mm	1.026
Rayon de braquage	mm	3.600

Roues

Description	U.M.	Valeur
Gommées		Pneumatique
Gommées optionnelles		Super élastique anti-trace

* Sans changer l'effort au crochet exprimé en N, la capacité de remorquage exprimée en Kg peut varier selon : la pente et le type de terrain sur lequel s'effectue le remorquage, l'utilisation ou non de lest et le type de roues montées sur l'engin et la remorque.



QR code à scanner
Pour plus de détails techniques

ATTELAGES STANDARD & ACCESSOIRES

Connections pour toutes demandes



BOULE/TIGE
CROCHET



ATTELAGE
À GOUPILLE

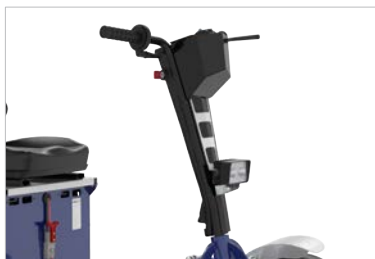

PANIER POUR
LE GUIDON



PANIER



FEUX AVANT ET
ARRIÈRE AUX LED

ÉCLAIRAGE DANS TOUTES SITUATIONS

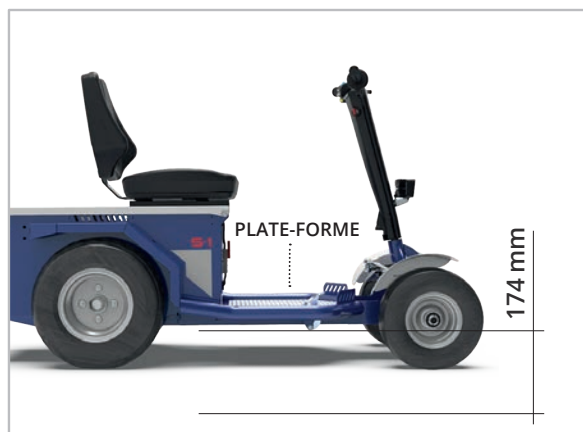



PLATE-FORME

174 mm

AGILITÉ MAXIMALE POUR UNE UTILISATION PLUS EFFICACE

Performances de traction

-  = Version standard
-  = Avec Upgrade

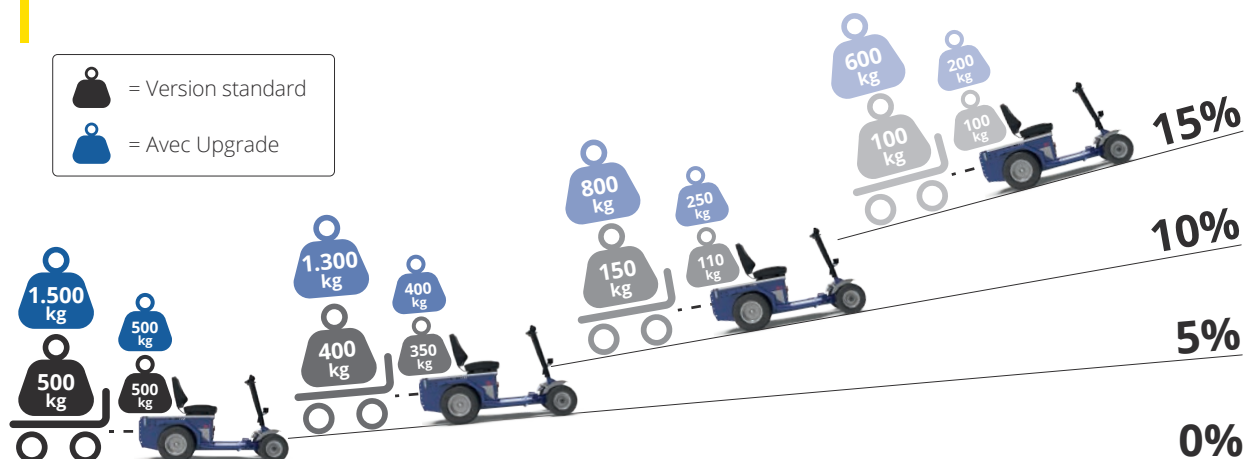

QR code à scanner
Voir tous les accessoires

Zallys®

• • • the passion for moving

S1

Z111.732



12,0 km/h 500 kg 1.500 kg



- Versátil y compacto.
- Para remolcar cargas de hasta 1.500 kg y transportar cargas de hasta 500 kg.
- Radio de giro estrecho.
- Con ruedas neumáticas para uso interior y exterior.
- Botón de ajuste de velocidad.
- Amplia gama de accesorios estándar o personalizables bajo pedido.



Escanea este código QR
para más información

ZALLYs srl
Via Palazzina 1 | 36030 Sarcedo (VI) - ITALY
www.zallys.com | sales@zallys.com



MANTENIMIENTO INDUSTRIAL



MANTENIMIENTO VERDE



Escanea este código QR
para ver todas las aplicaciones

ZALLYS srl
Via Palazzina 1 | 36030 Sarcedo (VI) - ITALY
www.zallys.com | sales@zallys.com

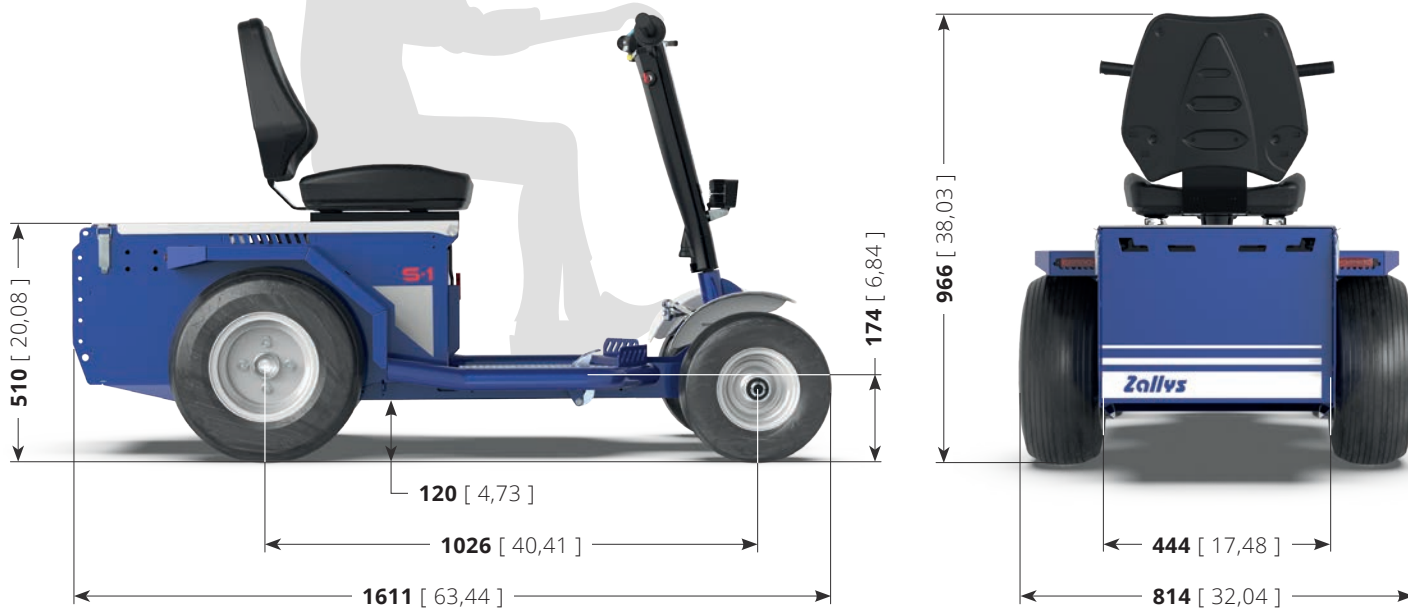

DATOS TÉCNICOS

Tipo de mando

Descripción	U.M.	Valor
Conducción		Manillares

Seguridad

Descripción	U.M.	Valor
Dispositivo de seguridad		Asiento con sensor
Dispositivo de parada de emergencia		Conector de alimentación desmontable

Prestaciones

Descripción	U.M.	Valor	Con Upgrade
Velocidad max. marcha adelante	km/h	10,0	12,0
Velocidad max. de marcha atrás	km/h	8,0	10,0
Capacidad de carga en plano	kg	500	
Pendiente max con carga	%	15	
Fuerza de tracción máx al gancho*	N	500	1.500
Espacio de parada en desaceleración (sin carga)	m	6	

Baterías

Descripción	U.M.	Valor
Tipo de baterías		Baterías de tracción de AGM
Tensión de la batería	V	12
Capacidad nominal 20 h	Ah	130
Cargador de baterías		Externo - en alta frecuencia

Motor

Descripción	U.M.	Valor
Motor		Elèctrico
Electricidad		Alterna
Motor	V	24
Potencia (S2 - 5')	kW	1
Pico de potencia máxima	kW	2,20

Medidas y Pesos

Descripción	U.M.	Valor
Peso incl.baterías	kg	211
Longitud	mm	1.611
Anchura	mm	814
Altura	mm	966
Altura de la superficie de carga	mm	510
Distancia de ejes	mm	1.026
Radio de giro	mm	3.600

Ruedas

Descripción	U.M.	Valor
Bandajes		Neumáticas
Bandajes opcionales		Superelástica antihuellas

* Sin modificar la fuerza del gancho expresada en N, la capacidad de remolque expresada en kg puede variar según: pendiente y tipo de terreno sobre el que se realiza el arrastre, uso o no de contrapesos y tipo de ruedas montadas en la máquina y remolque.



Escanea este código QR para más datos técnicos

GANCHOS ESTÁNDAR Y ACCESORIOS

Conexiones para todas las necesidades



GANCHO BOLA/PIN



GANCHO CON PERNO



CESTA PORTAOBJETOS PARA MANILLAR



CESTO



LUCES LED DELANTERAS Y TRASERAS

VISIBILIDAD EN CUALQUIER TIPO DE ENTORNO

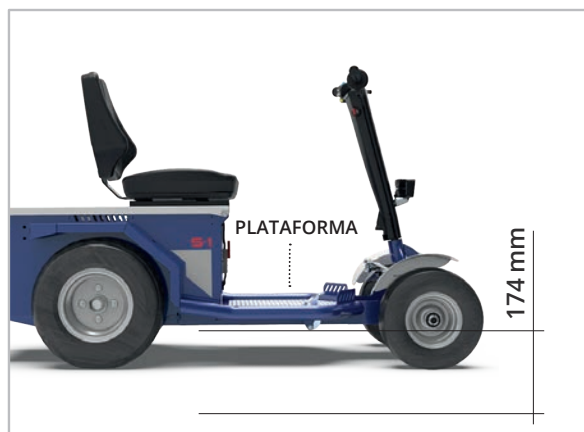

PLATAFORMA

174 mm

MÁXIMA AGILIDAD PARA UN USO MÁS EFICIENTE

Rendimiento en pendiente

-  = Versión estándar
-  = Con Upgrade

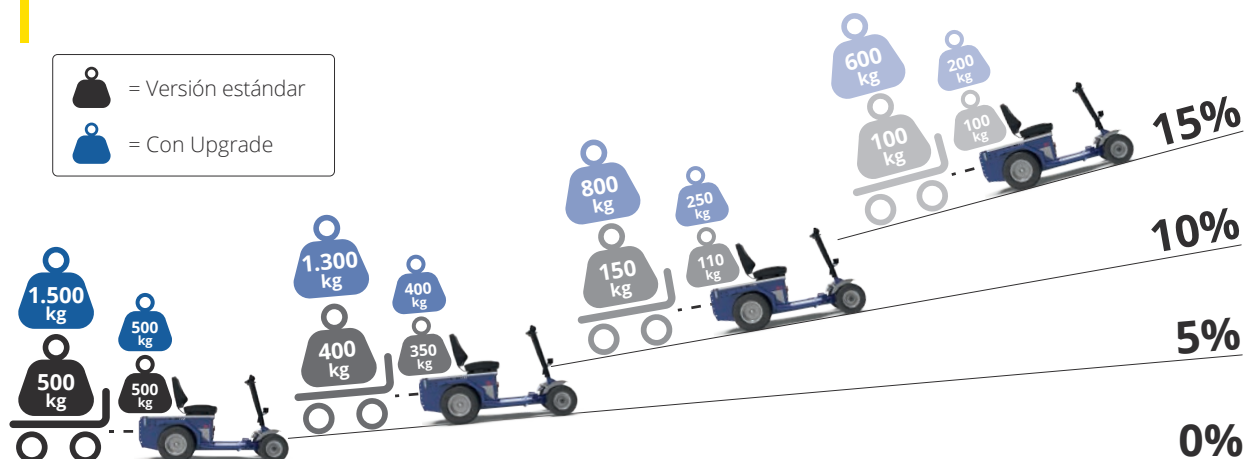

Escanea este código QR para ver todos los accesorios

Zallys®

• • • the passion for moving

S1

Z111.732



12,0 km/h 500 kg 1.500 kg



- Vielseitig und kompakt.
- Zum Ziehen von Lasten bis 1.500 kg und zum Tragen von bis zu 500 kg.
- Schmäler Wenderadius.
- Mit Lufträdern für den Innen- und Außenbereich
- Taste für die Einstellung der Geschwindigkeit.
- Große Auswahl an Standardzubehör oder auf Anfrage anpassbar



Scannen Sie diesen QR-Code
für weitere Informationen

ZALLYS srl
Via Palazzina 1 | 36030 Sarcedo (VI) - ITALY
www.zallys.com | sales@zallys.com



INDUSTRIELLE INSTANDHALTUNG



PFLEGE VON GRÜNFLÄCHEN



Scannen Sie diesen QR-Code
um alle Anwendungen zu sehen

ZALLYs srl
Via Palazzina 1 | 36030 Sarcedo (VI) - ITALY
www.zallys.com | sales@zallys.com

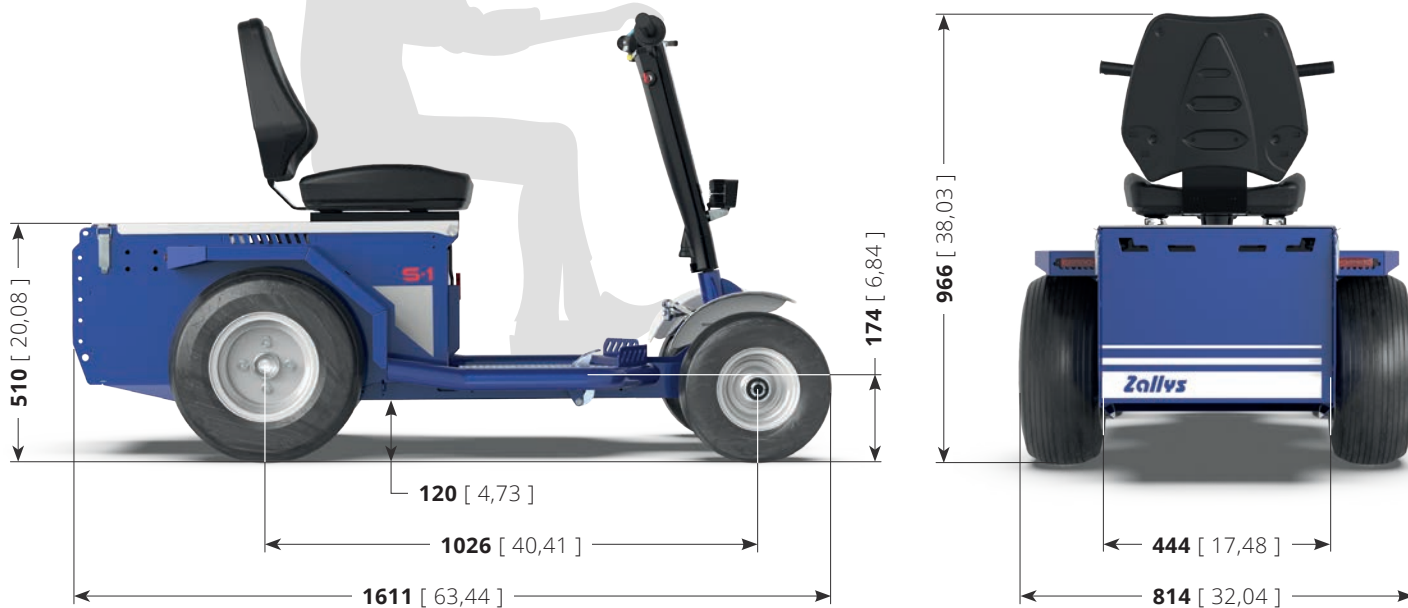

TECHNISCHE DATEN

Lenksysteme

Beschreibung	U.M.	Wert
Art der Anleitung		Lenker

Sicherheit

Beschreibung	U.M.	Wert
Totmann-Griff		Microswitch am Sitz
Not-Halt-Einrichtung		Lenker Handprotektoren

Leistung

Beschreibung	U.M.	Wert	Mit Upgrade
Max. Fahrgeschwindigkeit	km/h	10,0	12,0
Max. Fahrgeschwindigkeit Rückwärts	km/h	8,0	10,0
Maximale Tragfähigkeit auf der Ebene	kg	500	
Maximale Steigung	%	15	
Maximale Zugkraft am Haken*	N	500	1.500
Bremsbereich bei Verzögerung (ohne Ladung)	m	6	

Batterien

Beschreibung	U.M.	Wert
Batterietypologie		Traktion – Hermetische AGM
Batteriespannung	V	12
Nennkapazität 20/h	Ah	130
Ladegerät		Extern – Hochfrequenz

Motor

Beschreibung	U.M.	Wert
Motor		Elektrisch
Strom		Durchgehend
Spannung	V	24
Nennleistung (S2 - 5')	kW	1
Maximale Spitzenleistung	kW	2,20

Dimensionen und Gewicht

Beschreibung	U.M.	Wert
Gewicht mit Batterien	kg	211
Länge	mm	1.611
Breite	mm	814
Höhe	mm	966
Höhe der Ladefläche	mm	510
Achsabstand Räder	mm	1.026
Lenkdurchmesser	mm	3.600

Räder

Beschreibung	U.M.	Wert
Gummierung		Pneumatisch
Optionale Gummierungen		Superelastische Antispur

* Bei unveränderter Hakenkraft in N kann die Zugkraft in kg je nach Neigung und Art des Geländes, auf dem gezogen wird, Verwendung oder Nichtanwendung von Ballast und Räderart, die an Maschine und Anhänger montiert sind, variieren.



Scannen Sie diesen QR-Code für mehrere technische daten

STANDARDHAKEN & ZUBEHÖRTEILE

Kupplungen für jeden Bedarf



KUGELKOPF-/
STIFTKUPPLUNG



HAKEN
MIT STIFT



LENKERKORB



PRITSCHÉ



LED-BELEUCHTUNG
VORNE UND HINTEN

SICHTBARKEIT IN JEDER UMWELT

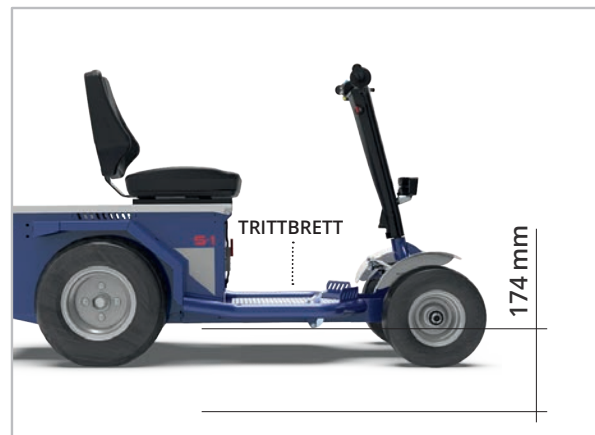

TRITTBRETT

174 mm

MAXIMALE AGILITÄT FÜR EINE EFFIZIENTER NUTZUNG

Schlepplleistung

- = Standardversion
- = Mit Upgrade

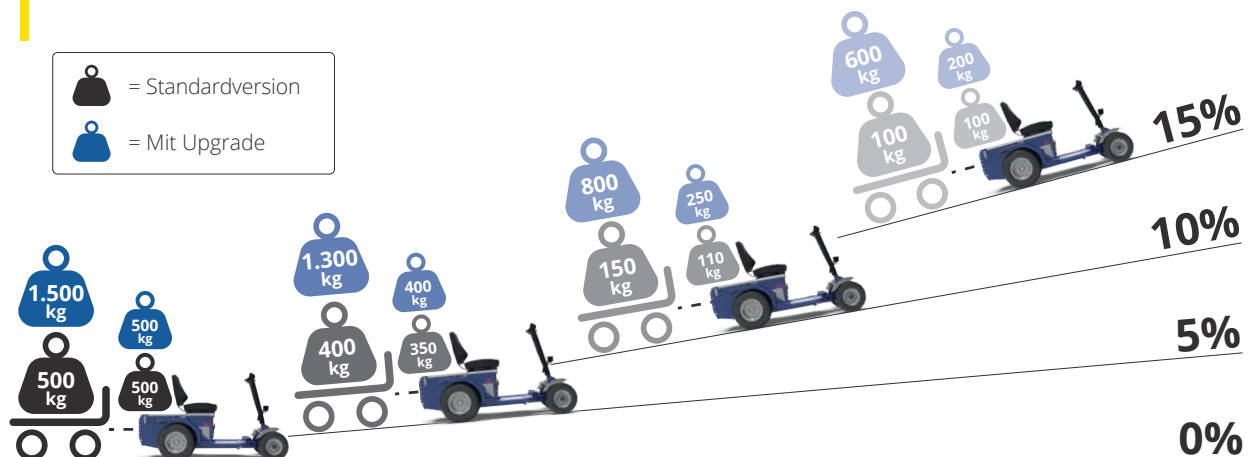

Scannen Sie diesen QR-Code
um alle Zubehörteile zu sehen