



M6.5

Mover elettrico industriale

M6.5

Z194.720



4,5 km/h



400 kg



6.000 kg



15 %



- Per carichi fino a 6.000 kg.
- Ruota sterzante collegata al timone.
- Ruote pneumatiche.
- Sistema di sollevamento elettrico opzionale
- Selettore di velocità a 5 livelli.
- Ampia gamma di accessori e connessioni.

Vista Frontale



Vista Laterale



Vista Posteriore



**Zollys**[®]

TABLE:

Z194.720**M6.5**

Unit: mm [inch]

Settori principali

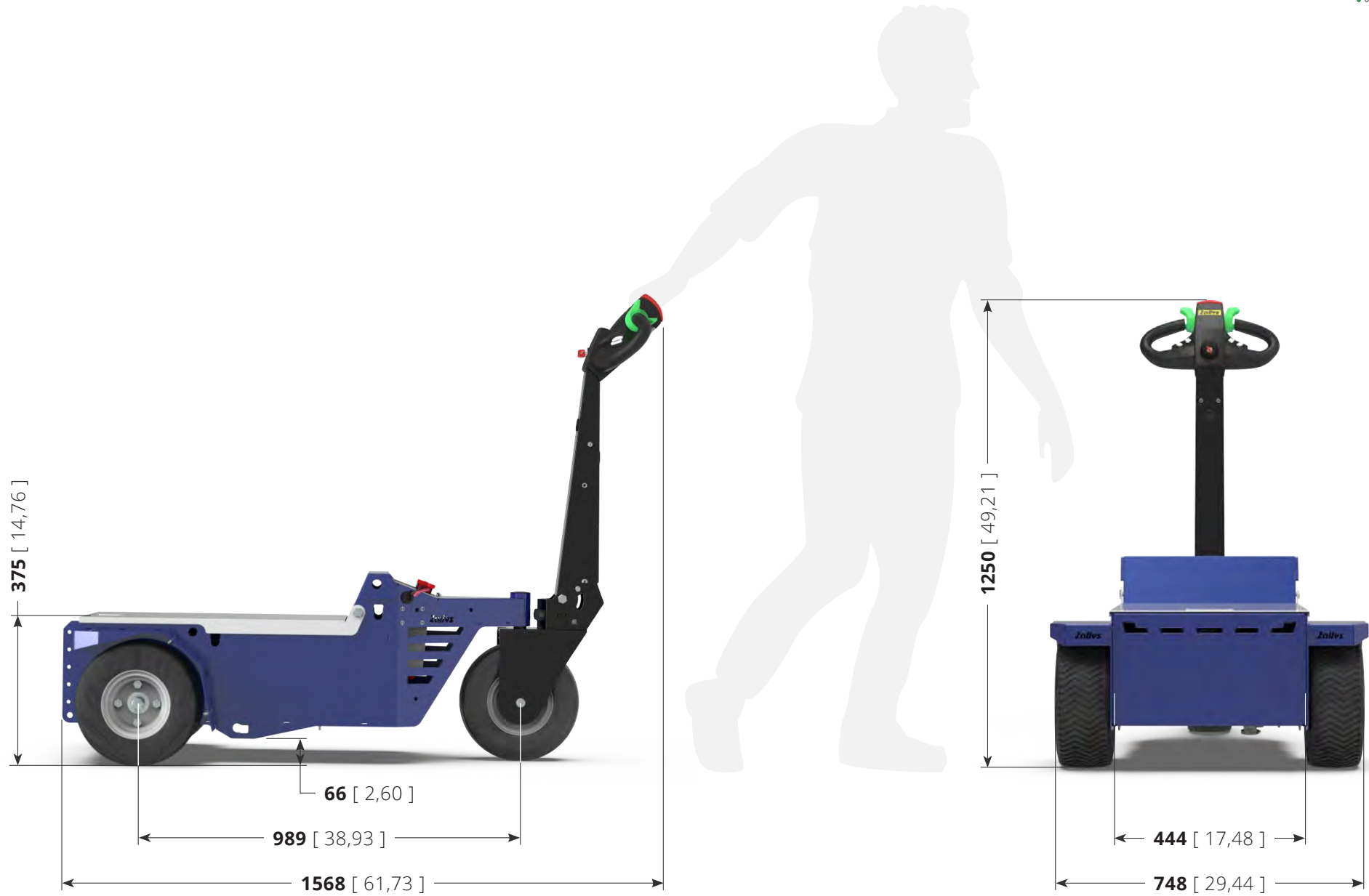

INDUSTRIA
AUTOMOBILISTICA



INDUSTRIA
METALLURGICA
TORNERIE



CARPENTERIE
VERNICIATURE



INDUSTRIA DEL VETRO



LINEE PRODUTTIVE



LOGISTICA GDO



AEROPORTI

Prestazioni di traino

Fermo restando invariata la forza al gancio espressa in N, la capacità di traino espressa in kg **può variare in base a:**

- **tipo di terreno** sul quale viene effettuato il traino;
- traino su suolo **piano o in pendenza**;
- utilizzo o meno di **zavorre**;
- **tipo di ruote** montate su macchina e carrello.

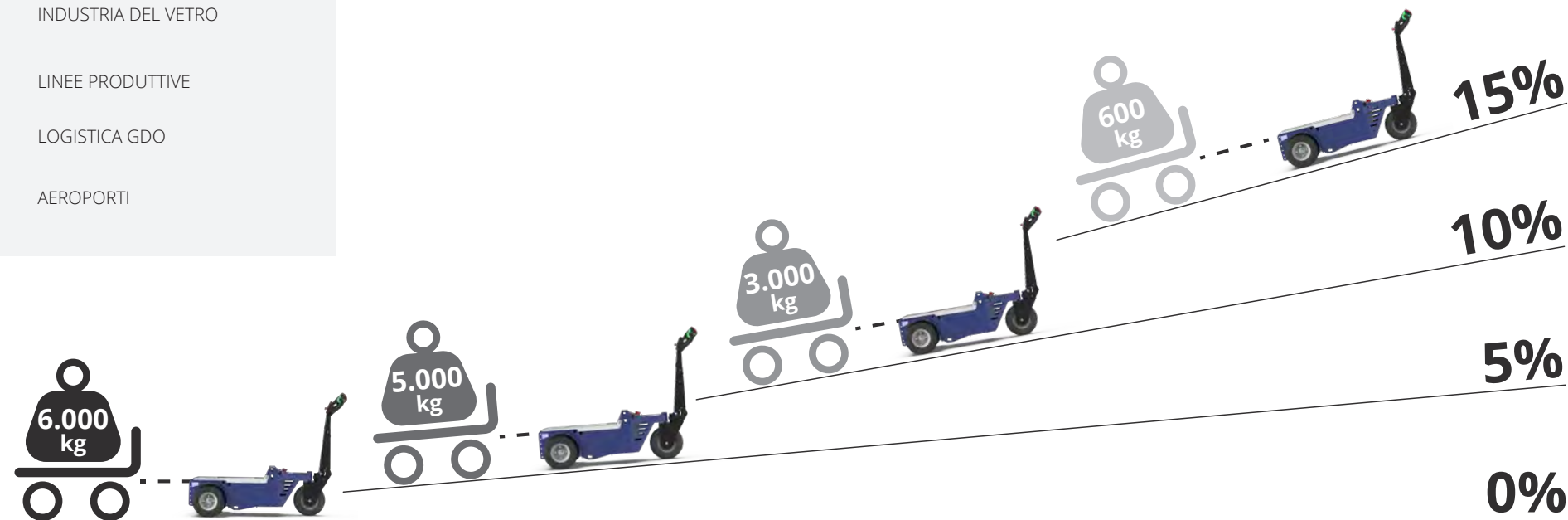

Regolazione della velocità a 5 livelli

Sul nuovo timone di M6.5 firmato Zallys troviamo montato **di serie** un pulsante per regolare la velocità della macchina. Premendolo, ad ogni click si passa alla marcia successiva. Ciò permette una rapida e comoda selezione della velocità adeguata al tipo di manovra da affrontare. Il sistema **Flex-to-Go** è stato studiato per avere maggiore manovrabilità negli spazi ristretti e più velocità nei tragitti lunghi.

Ogni click aggiunge il **20% di velocità in più** rispetto alla marcia precedente.

Rampa velocità:

20% - 40% - 60% - 80% - 100%

Una volta arrivati alla quinta marcia, premendo il pulsante si ritorna alla prima.

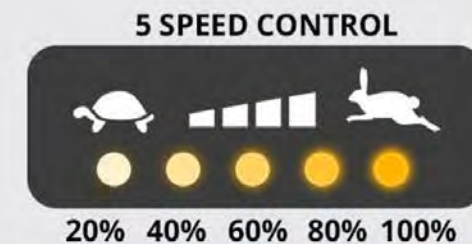

Guida ergonomica

La testata Zallys è stata studiata e realizzata per rendere più ergonomico l'utilizzo della macchina da parte dell'operatore, garantendo il giusto **comfort su un uso prolungato** durante il turno di lavoro. Il suo **design ergonomico** permette di avere **tutti i pulsanti dei comandi a portata di mano**, il display con indicata la carica residua della batteria e la chiave per un'accensione veloce e comoda. La **struttura** è composta da **materiali resistenti** in caso di urti accidentali.

Chiave di accensione

Pulsante
selezione 5 velocità

Pulsante anti-
schiacciamento



Pannello di controllo

Pulsante avvisatore
acustico

Comandi di marcia ad
azione mantenuta



Ruote pneumatiche

M6.5 monta ruote pneumatiche, adatte sia per un utilizzo all'interno che all'esterno, garantendo sempre la massima aderenza e un bassissimo livello di vibrazioni. Inoltre, le ruote di **M6.5** sono più piccole rispetto a quelle degli altri trainatori Zallys, per aumentare stabilità e trazione. La ruota di direzione è direttamente collegata al timone, per movimentare con incredibile facilità e precisione anche i carichi più pesanti e ingombranti.



Autonomia per un'intera giornata di lavoro

M6.5 è alimentato da due batterie da 105/130 Ah, che garantiscono alla macchina un'**autonomia di 8 ore lavorative ad uso continuativo**. In caso di utilizzo particolarmente intenso, è possibile passare a delle batterie con amperaggio maggiore, oppure montare un **pacco batterie estraibile e intercambiabile**, per avere la macchina sempre disponibile **24 ore su 24, 7 giorni su 7**. In entrambi i casi sono facili e sicure da ricaricare, grazie al caricabatterie esterno ad alta frequenza.



Sistema di zavorre modulare

Il **sistema modulare Zallys** garantisce la **massima flessibilità** nell'aumentare le prestazioni del veicolo. Con un **peso unitario di soli 10 kg**, le singole zavorre sono leggere e possono essere equipaggiate **senza sforzo fisico da parte dell'operatore**, pur mantenendo tutta la loro efficacia.

GANCI STANDARD



GANCIO CON
SFERA-PERNO



GANCIO
CON SPINA

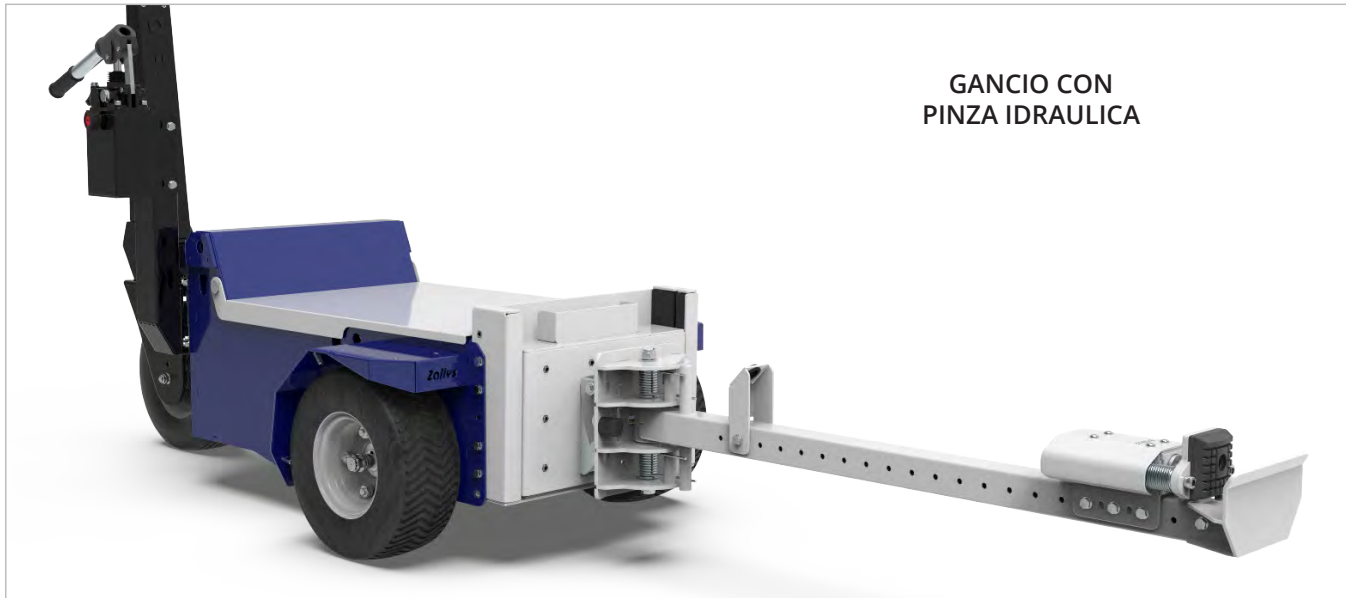

GANCIO CON
PINZA IDRAULICA

GANCI STANDARD

Sistema di sollevamento elettrico (opzionale)



Su **M6.5** è possibile installare un **kit per il sollevamento elettrico**, che permette all'operatore di agganciare e sollevare con semplicità e in tutta sicurezza il trainatore ad un rimorchio a 2 ruote, semplicemente azionando i comandi direttamente dal timone.



ACCESSORI





Esempi di applicazione

nei vari settori produttivi



INDUSTRIA METALLURGICA

Zallys
... the passion for moving





MANUTENZIONI INDUSTRIALI

Zallys
... the passion for moving





VERNICIATURE

Zallys
... the passion for moving



INDUSTRIA NAVALE

Zollis
... the passion for moving





• • • the passion for moving

Zallys srl srl - Via Palazzina 1, Sarcedo
36030 (VI) - Italia

Contatti:

sales@zallys.com
+39 0445 366785

Web site:

www.zallys.com





M6.5

Industrial electric cart mover

M6.5

Z194.720



4,5 km/h



400 kg



6.000 kg



15 %



- For loads up to 6.000 kg.
- Swivel wheel linked to the tiller.
- Pneumatic wheels.
- Optional electric lifting system.
- 5-levels speed adjustment.
- Wide range of accessories and connections.

👁 **Front View**



👁 **Side View**



👁 **Rear View**



**Zollys**[®]

TABLE:

Z194.720

M6.5

Unit: mm [inch]

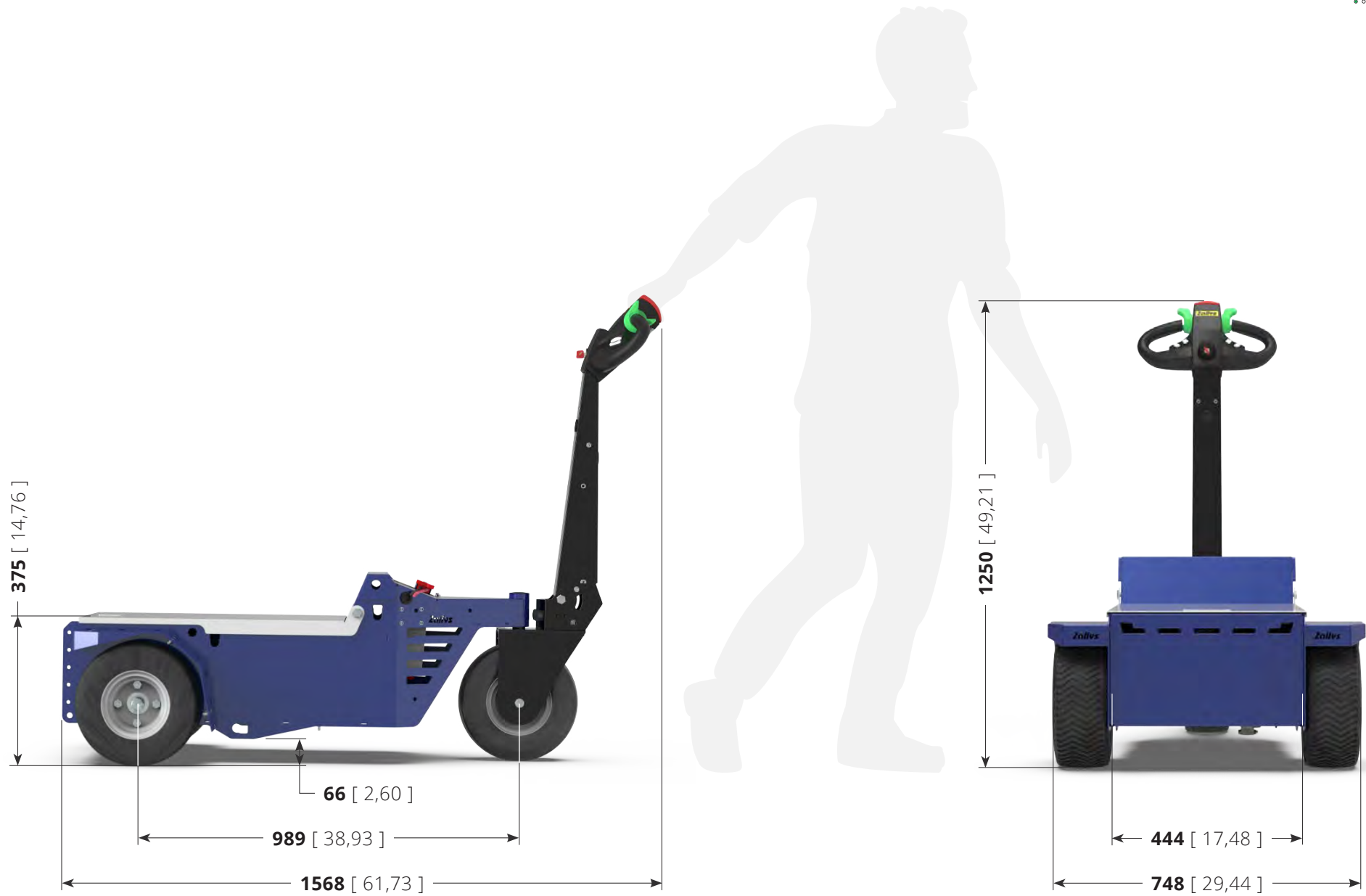
Main sectors



AUTOMOTIVE



METALLURGICAL
AND TURNING
INDUSTRY



CARPENTRY AND
PAINT SHOPS



GLASS INDUSTRY



PRODUCTION LINES



INTEGRATED LOGISTICS
& RETAIL CHAINS



AIRPORTS

Performances on slopes

While the force expressed in N at the hook remains unchanged, the following circumstances **may affect the towing capacity expressed in kg:**

- **type of ground** on which the towing is performed;
- towing on **flat ground or on a slope**;
- use (or not) of **ballasts**;
- **type of wheels** mounted on the vehicle and on the trailer.

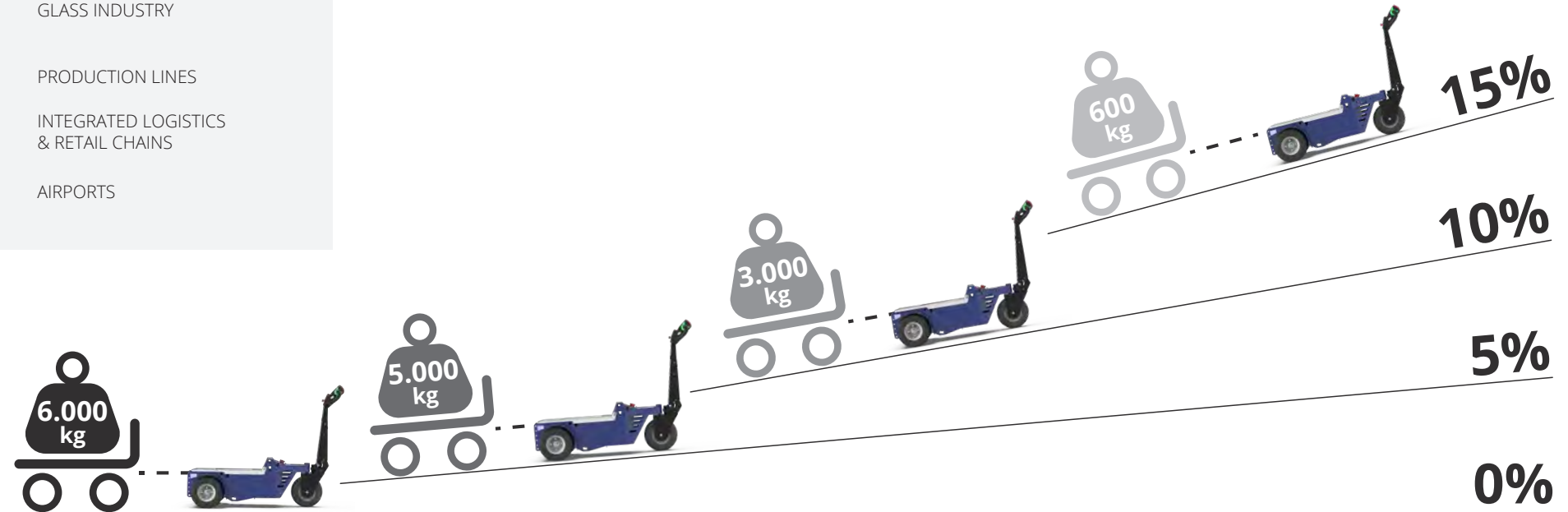

5 levels speed adjustment

On the new M6.5 tillerhead by Zallys a button for the adjustment of the speed of the machine is mounted **as standard**. By clicking it, at each click you switch to the next level. This allows a fast and easy selection of the correct speed based on the kind of manoeuvre. **The Flex-to-Go system** has been studied to give a better maneuverability in confined spaces and more speed on the longer journeys.

Each click adds **20% more speed**.

Speed ramp:

20% - 40% - 60% - 80% - 100%

Once the maximum speed is reached, by pressing the button again it returns to 20%.

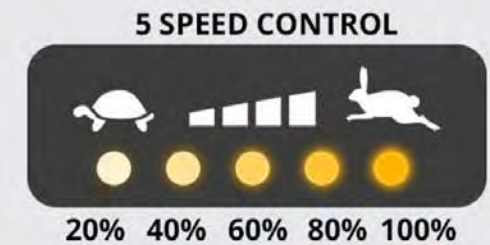

Ergonomic driving

Zallys' tillerhead has been conceived and produced to make the use of the machine more ergonomic for the operator, guaranteeing the right **comfort while driving during the work shift**. Its **ergonomic design** allows to have **all the driving controls at your fingertips**, the display with the battery charge level and the power key for an easy and fast ignition. **The structure** is made of **resistant materials** in case of accidental bumps.

Power key

5 speed
selection

Anti-crush
reverse button



Dashboard

Acoustic alarm

Maintained action
drive controls



Pneumatic wheels

M6.5 is equipped with **pneumatic wheels**, suitable both for indoor and outdoor use, always guaranteeing the maximum grip and a really low level of vibrations. Moreover, the traction wheels are smaller compared to the other Zallys tow tugs' ones, to increase tow capacity and stability. The direction wheel is directly linked to the tiller, to move with incredible ease even the heaviest and bulkiest of loads.



Autonomy for a full workday

M6.5 is powered by two 105/130 Ah batteries, which guarantee the machine for **8 hours operation at continuous use**. In case of a particularly intense use, it is possible to equip **higher amperage batteries**, or equip an **interchangeable and extractable battery pack**, for a **24 / 7 operation**. In both cases they are easy and safe to recharge, thanks to the high frequency external battery pack.



Modular ballast system

Zallys modular system guarantees **maximum flexibility** on increasing the vehicle's performances. With just **10 kg unit weight**, single ballasts are lightweight and can be equipped **without physical effort by the operator**, while maintaining all their effectiveness.

STANDARD HITCH



BALL/PIN
HITCH



DROP PIN
HITCH

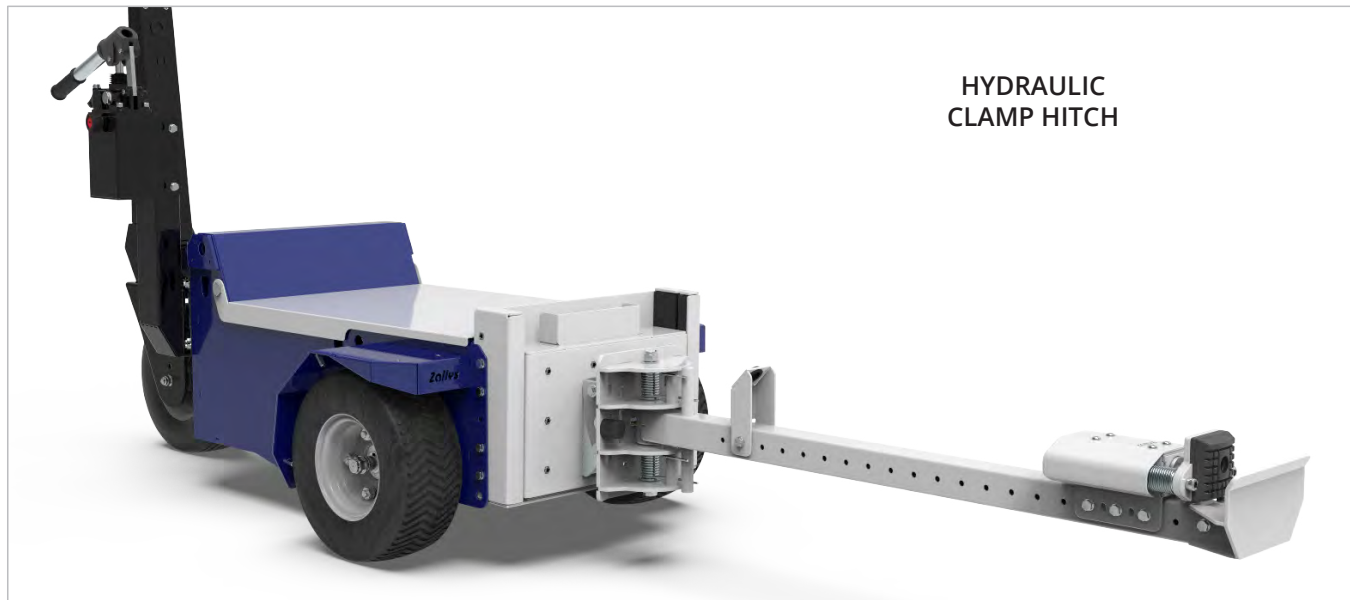

HYDRAULIC
CLAMP HITCH

STANDARD HITCH

Electric lifting system (optional)



On request, it is possible to equip **M6.5** with an **electric lifting system kit**, which allows the operator to easily and safely lift 2 wheeled trailers, directly from the controls on the tillerhead.

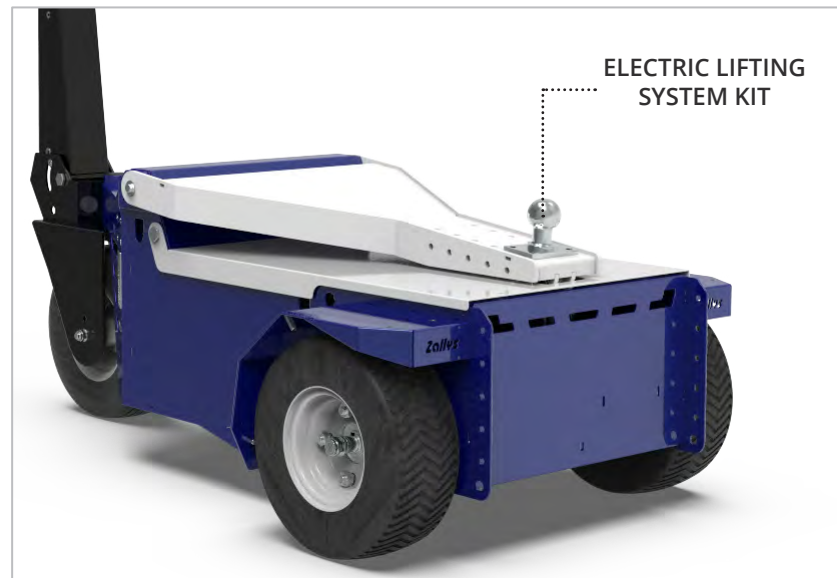

ACCESSORIES





Examples of applications

on various production sectors



METALLURGICAL INDUSTRY

Zallys
... the passion for moving





INDUSTRIAL MAINTENANCE

Zallys
... the passion for moving





PAINTING INDUSTRY

Zollis
... the passion for moving



SHIPBUILDING INDUSTRY

Zallys
the passion for moving





• • • the passion for moving

Zallys srl srl - Via Palazzina 1, Sarcedo
36030 (VI) - Italia

Contacts:

sales@zallys.com
+39 0445 366785

Web site:

www.zallys.com





M6.5

Tracteur pousseur à batterie

M6.5

Z194.720



4,5 km/h



400 kg



6.000 kg



15 %



- Pour des charges jusqu'à 6000 kg.
- Roue directionnelle liée au timon.
- Avec roues pneumatiques.
- Système de levage électrique en option.
- Bouton pour le réglage à 5 vitesses.
- Large gamme des accessoires et attelages.

Vue de Face



Vue Latérale



Vue Arrière



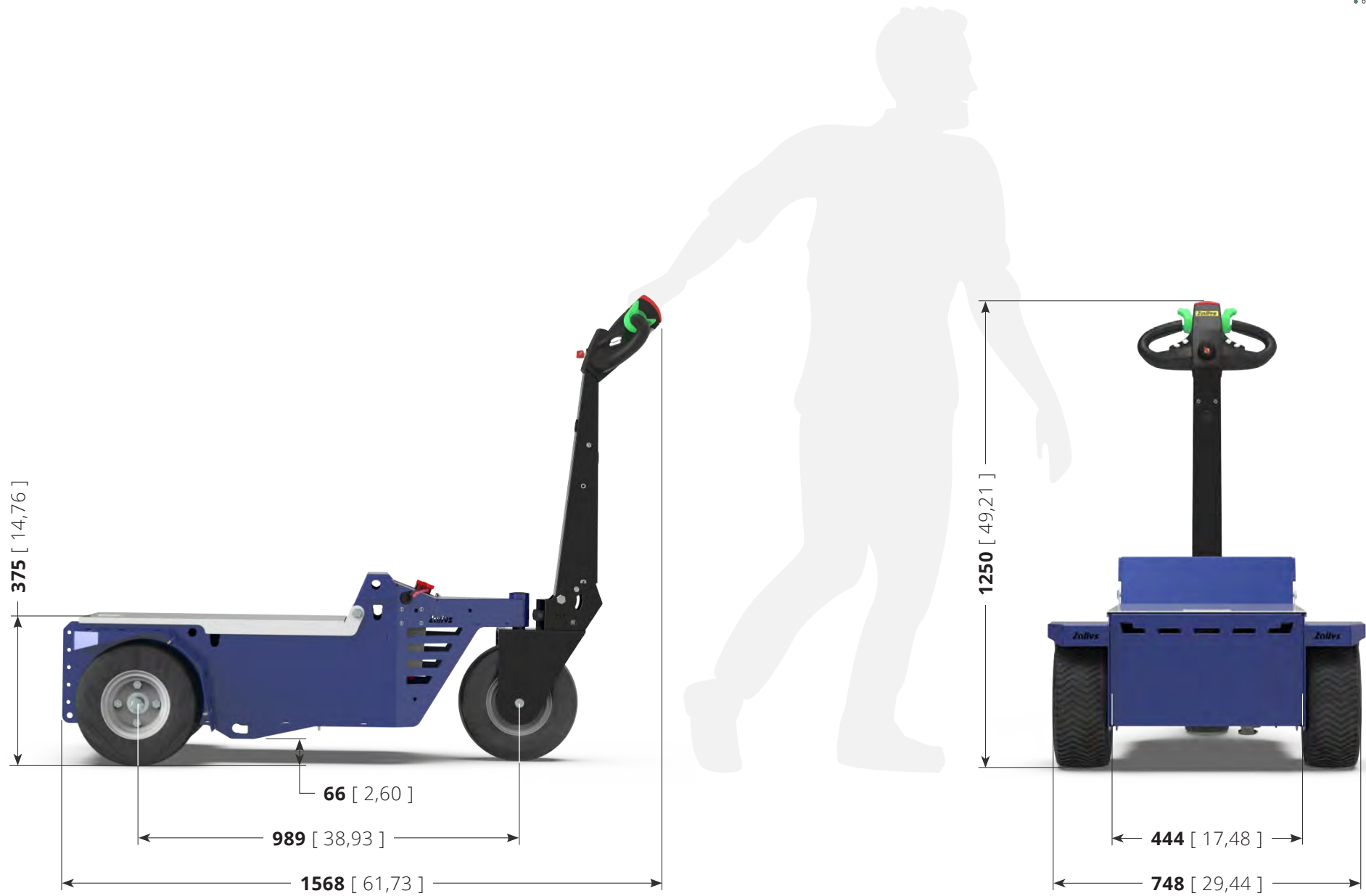

	TABLE: Z194.720	M6.5	Unit: mm [inch]
--	---------------------------	------	-----------------

Principaux secteurs



INDUSTRIE
AUTOMOBILE



INDUSTRIE
MÉTALLURGIQUE
ET DU TOURNAGE



ATELIERS DE
MENUISERIE ET
DE PEINTURE



INDUSTRIE DU VERRE



LIGNES DE PRODUCTION



LOGISTIQUE
INTÉGRÉE ET CHAÎNES
DE MAGASINS



AÉROPORTS

Performances de traction

Compte tenu des valeurs standard de l'effort de traction max au crochet en N, la capacité de traction en kg **peut varier selon:**

- **type de sol** où on travaille;
- **traction sur plan** or en pente;
- utilisation ou **pas de lests**;
- **typologies de roues** de la machine et du chariot.

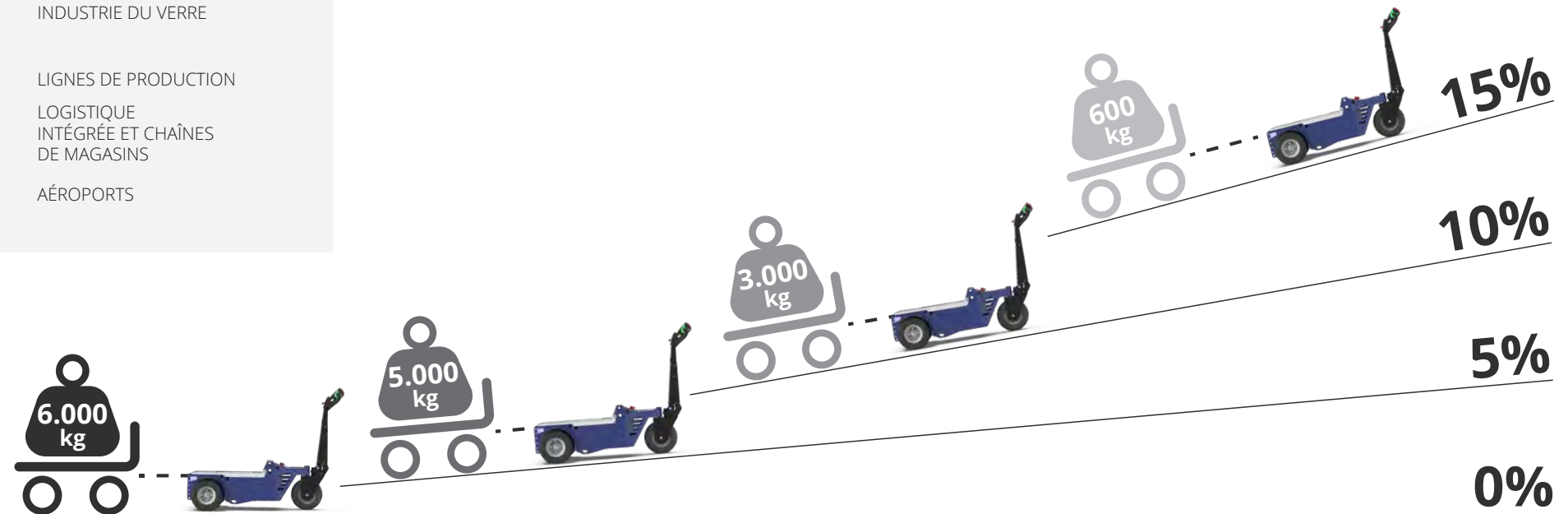

Interrupteur 5 vitesses

Le bouton à **5 vitesses est monté de série sur le nouvel timon Zallys du M6.5**. En y appuyant dessus, à chaque cliques, vous passez au step suivant. Cela permet une sélection rapide et pratique de la vitesse correcte pour le type de manœuvre que l'opérateur doit faire. Le **système Flex-to-Go** a été conçu pour apporter une plus grande maniabilité dans les espaces étroits et plus de vitesse sur les longues distances.

Chaque cliques **ajoute 20% de vitesse de plus** que l'étape précédente

Valeurs vitesse:

20% - 40% - 60% - 80% - 100%

Quand la vitesse est au maximum, en appuyant à nouveau sur le bouton, elle revient au 20%.



5 SPEED CONTROL

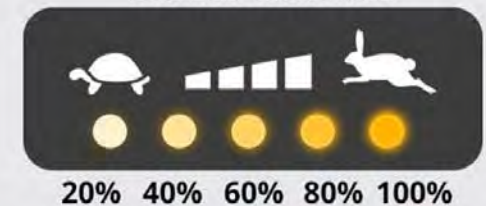

Conduite ergonomique

La tête du timon Zallys est pensée pour rendre l'utilisation de la machine la plus ergonomique possible pour l'opérateur, en garantissant le **correct confort pendant un usage prolongé** sur le lieu du travail. Toutes les **commandes à portée de main**: dans le tableau de bord, des voyants à LED sont toujours visibles, le niveau de charge aussi et la clé pour permettre un allumage vite et confortable. La **structure** est faite avec **matériaux résistants** aux chocs accidentels.

Interrupteur à clé

Bouton pour
selectionner la vitesse

Bouton anti-
écrasement



..... Panneau de commande

..... Klaxon

..... Commande à action
maintenue



Roues pneumatiques

M6.5 monte, en série, **roues pneumatiques**, aptes à être utilisés surtout à l'extérieur, sur de terrains boueux ou difficiles, mais parfaites aussi à l'intérieur; ces roues garantissent une adhérence maximale et des vibrations presque absentes. En plus, **le M6.5** est équipé avec roues plus petites par rapport aux standards de autres produits Zallys, afin d'augmenter stabilité et traction. La roue directionnelle est branché directement au timon, pour permettre une maniabilité optimale et grande précision en présence des charges très lourds et volumineux.



Autonomie des batteries pour la toute la journée

M6.5 fonctionne avec 2 batteries au plomb 105/130 Ah: elles permettent de travailler pour **8 heures en continu**. En cas d'utilisation intensive, on peut équiper la machine avec **batteries plus puissantes ou monter un pack batteries amovible et interchangeable**, pour **travailler 24/7** Dans les deux cas, pas de problèmes avec le rechargement, grâce au chargeur extérieur à haute fréquence.



Système modulaire de lests

Le système modulaire Zallys garantit une flexibilité maximale en augmentant les performances du véhicule. Chaque lest a **un poids unitaire de 10 kg**: elles sont très légères et **l'opérateur peut les manipuler sans aucun effort physique**.

CROCHETS STANDARD

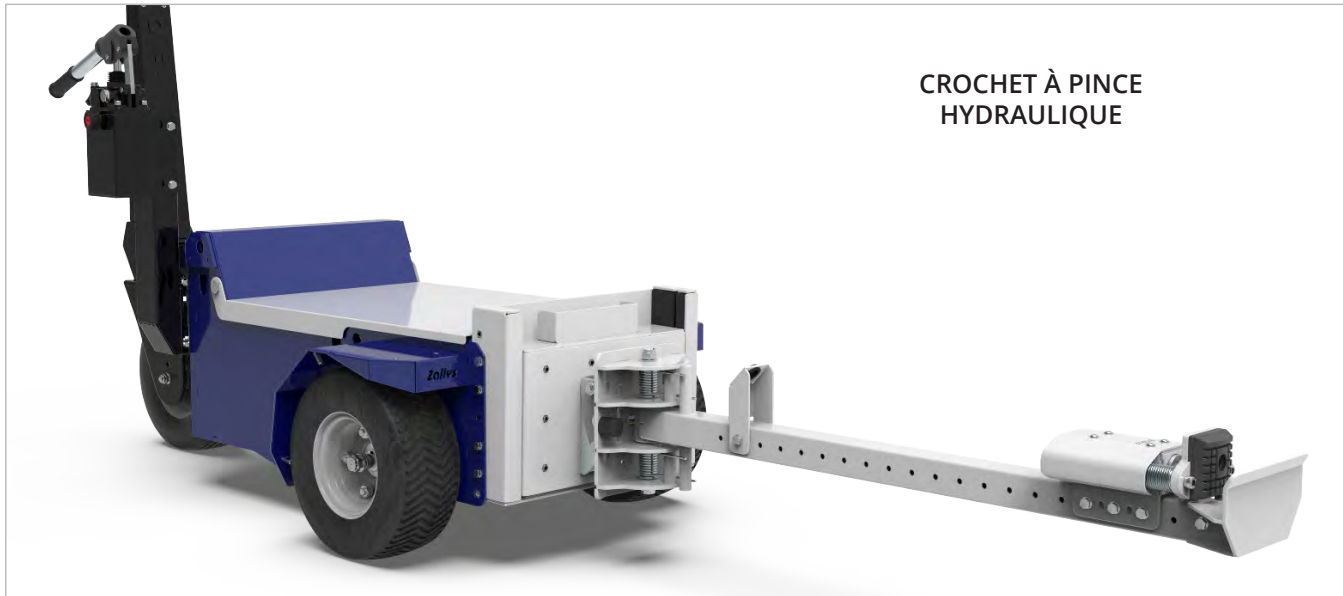
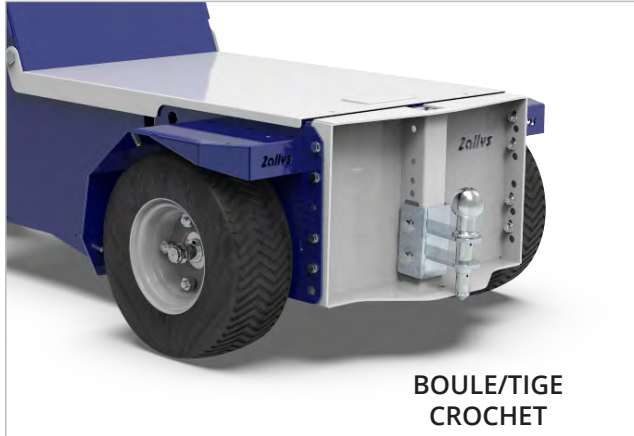

CROCHETS STANDARD

Système de levage électrique (optionnel)



Le M6.5 peut être équipé avec un **système de levage électrique**: cette configuration permet à l'opérateur d'accrocher et soulever un remorque avec 2 roues, de façon très simple, cet-à-dire en actionnant les commandes directement de la tête du timon.

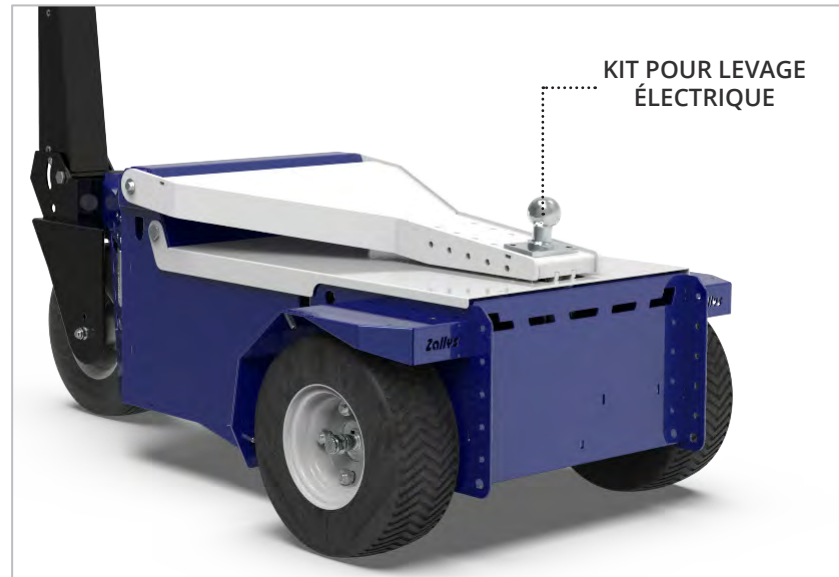
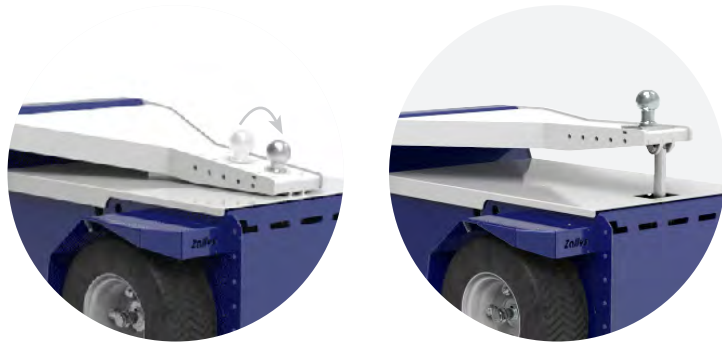

ACCESSOIRES





Exemples d'applications

Dans les différents secteurs productifs



INDUSTRIE MÉTALLURGIQUE

Zallys®
... the passion for moving





MAINTENANCES INDUSTRIELLES

Zallys
... the passion for moving





PEINTURE INDUSTRIELLE

Zallys
... the passion for moving



INDUSTRIE NAVALE

Zallys
the passion for moving





• • • the passion for moving

Zallys srl srl - Via Palazzina 1, Sarcedo
36030 (VI) - Italia

Contatti:

sales@zallys.com
+39 0445 366785

Web site:

www.zallys.com





M6.5

Empujador eléctrico de carga industrial

M6.5

Z194.720



4,5 km/h



400 kg



6.000 kg



15 %



- Para cargas de hasta 6.000 kg.
- Rueda directriz conectada al timón.
- Ruedas neumáticas.
- Sistema elevador eléctrico opcional
- Selector de velocidad de 5 niveles.
- Amplia gama de accesorios y conexiones.

Vista Frontal



Vista Lateral



Vista Trasera



**Zollys**[®]

TABLE:

Z194.720

M6.5

Unit: mm [inch]

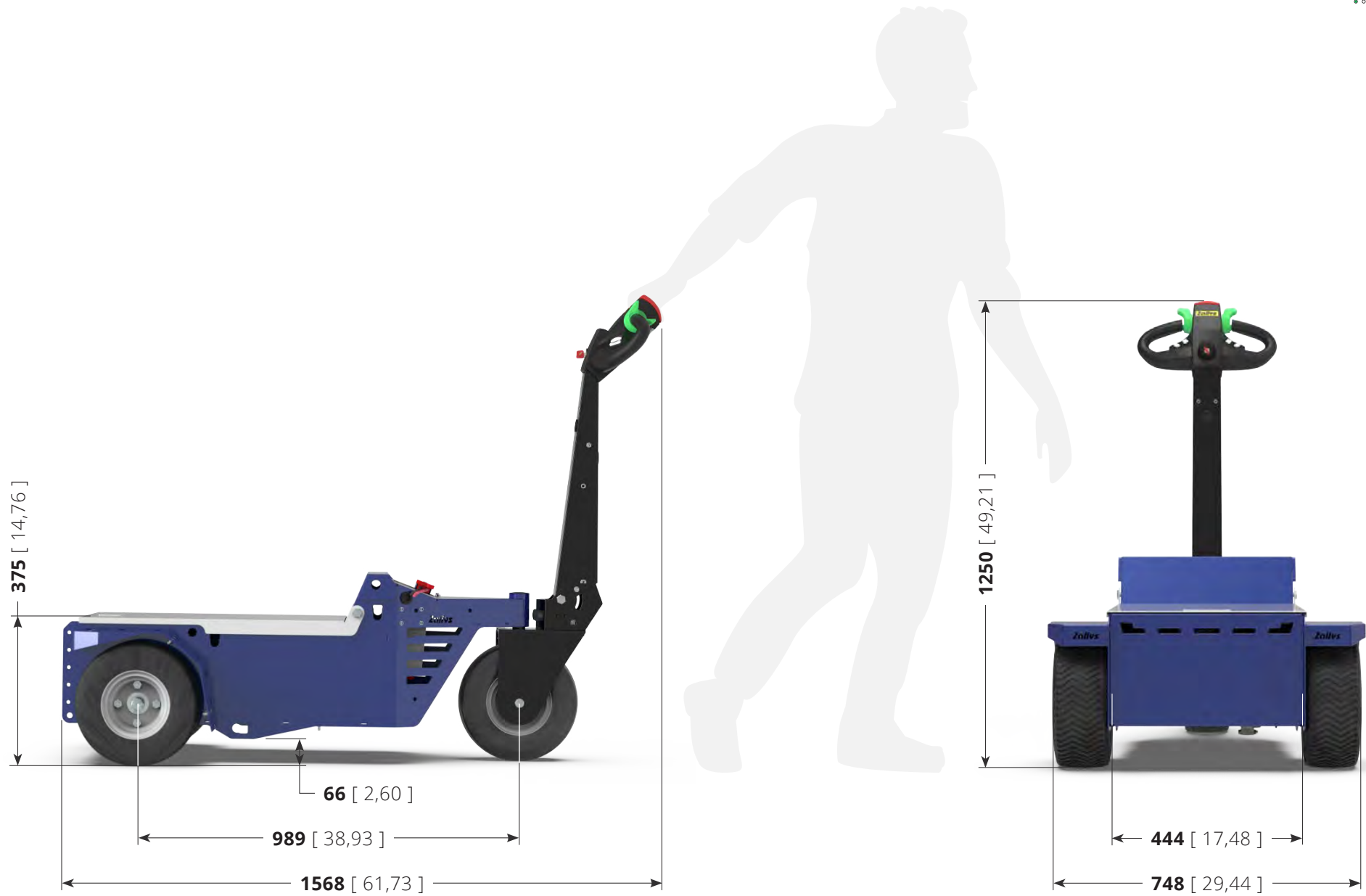
Sectores principales



INDUSTRIA
AUTOMOTRIZ



INDUSTRIA
METALÚRGICA
Y DE TORNEADO



CARPINTERÍA
Y PINTURA



INDUSTRIA DEL VIDRIO



LÍNEAS DE PRODUCCIÓN



LOGÍSTICA INTEGRADA Y
CADENAS MINORISTAS



AEROPUERTOS

Rendimiento de remolque

Sin cambiar la fuerza sobre el gancho expresada en N, la capacidad de remolque expresada en kg **puede variar en**

función de:

- **tipo de terreno** en el que se lleva a cabo el remolque;
- **remolque en terreno** plano o inclinado;
- **uso o no** de contrapesos;
- **tipo de ruedas** montadas en la máquina y carro.

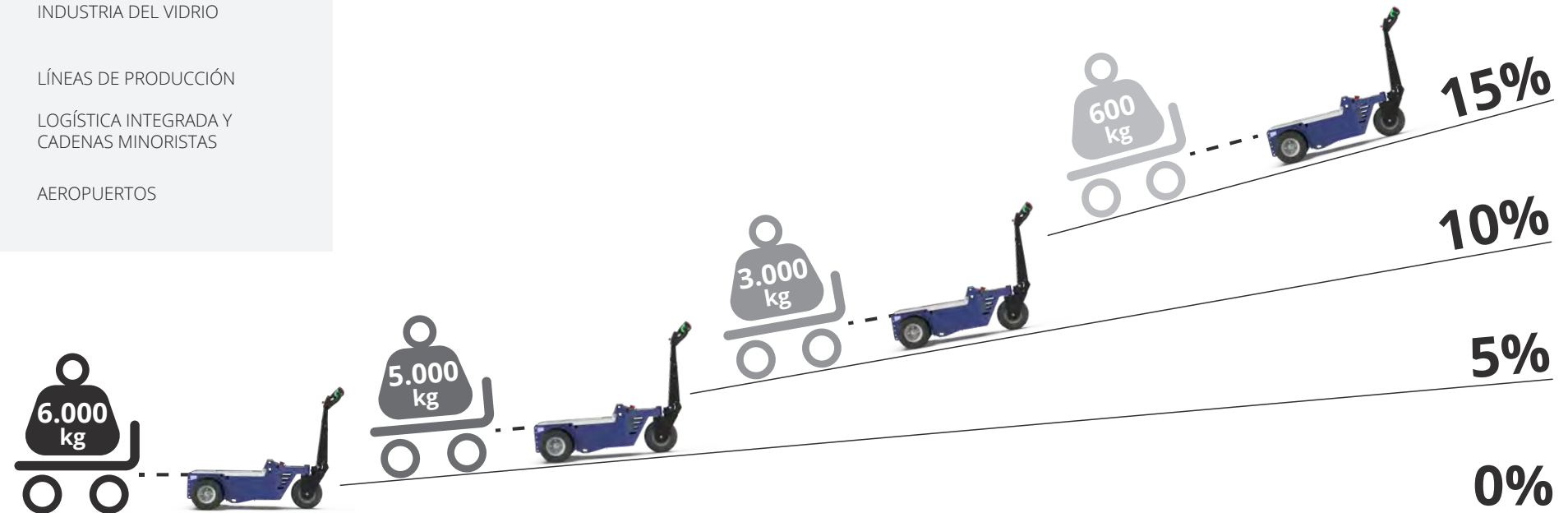

Ajuste de velocidad de 5 niveles

En el **nuevo timón Zallys M6.5** encontramos un botón para ajustar la velocidad de la máquina **de serie**. Al presionarlo, cada clic cambia a la siguiente marcha. Esto permite una selección rápida y cómoda de la velocidad adecuada al tipo de maniobra a afrontar. El **sistema Flex-to-Go** ha sido diseñado para tener una mayor maniobrabilidad en espacios reducidos y más velocidad en viajes largos.

Cada clic **agrega un 20% más de velocidad** que la marcha anterior.

Rampa de velocidad:

20% - 40% - 60% - 80% - 100%

Una vez en la quinta marcha, al presionar el botón se vuelve a la primera.

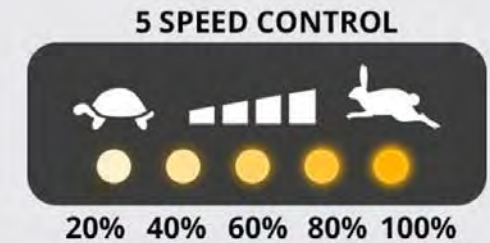

Conducción ergonómica

El **cabezal Zallys** ha sido diseñado y construido para hacer más ergonómico el uso de la máquina por parte del operador, asegurando la **comodidad adecuada en un uso prolongado** durante el turno de trabajo. Su **diseño ergonómico** permite tener **todos los botones de control al alcance de la mano**, la pantalla indica la carga restante de la batería y la llave para un encendido rápido y conveniente. La **estructura** está fabricada con **materiales resistentes** en caso de impactos accidentales.

Llave de contacto

Botón de selección de velocidad

Botón anti-aplastamiento



Panel de control

Botón de la bocina

Mandos de marcha con acción mantenida



Ruedas neumáticas

M6.5 está equipado con ruedas neumáticas, aptas tanto para uso interior como exterior, asegurando siempre la máxima tracción y un nivel muy bajo de vibraciones. Además, las ruedas del **M6.5** son más pequeñas que las de otros productos Zallys, para aumentar la estabilidad y la tracción. El volante está conectado directamente al timón para mover incluso las cargas más pesadas y voluminosas con una facilidad y precisión increíbles.



Autonomía para todo un día de trabajo

M6.5 está alimentado por dos baterías de 105/130 Ah, que garantizan a la máquina una autonomía de **8 horas de trabajo para uso continuo**. En caso de uso particularmente intenso, es posible cambiar a baterías de mayor amperaje, o montar un **paquete de baterías extraíble e intercambiable**, para tener la máquina siempre disponible las **24 horas del día, los 7 días de la semana**. En ambos casos son fáciles y seguros de recargar, gracias al cargador externo de alta frecuencia.



Sistema de contrapesos modular

El **sistema modular de Zallys** garantiza la **máxima flexibilidad** para aumentar el rendimiento del vehículo. Con un **peso unitario de sólo 10 kg**, los contrapesos individuales son ligeros y el operador puede equiparlos **sin esfuerzo físico**, manteniendo toda su eficacia.

GANCHOS ESTÁNDAR



GANCHO
BOLA/PIN



GANCHO
CON PERNO

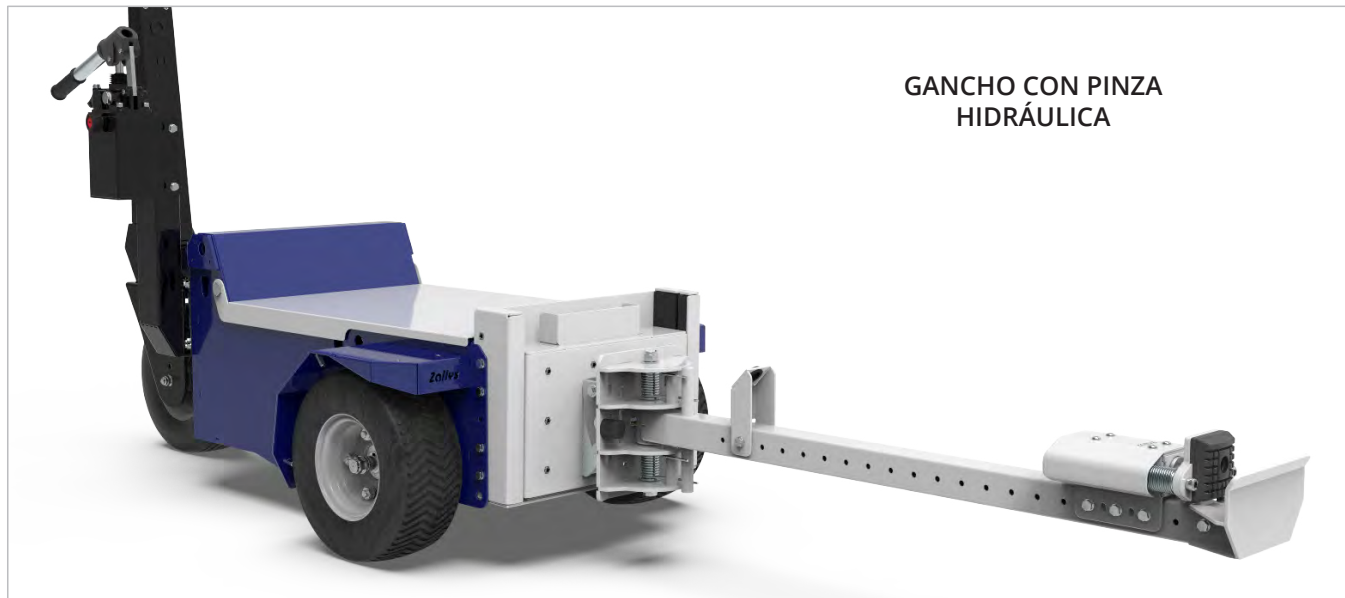

GANCHO CON PINZA
HIDRÁULICA

GANCHOS ESTÁNDAR

Sistema de elevación eléctrico (opcional)



En **M6.5** es posible instalar un **kit de elevación eléctrica**, que permite al operador enganchar y levantar de forma fácil y segura el transportador a un remolque de 2 ruedas, simplemente operando los controles directamente desde la barra de tiro.



ACCESORIOS





Ejemplos de aplicación

en los distintos sectores productivos



INDUSTRIA METALÚRGICA

Zallys®
... the passion for moving





MANTENIMIENTO INDUSTRIAL

Zallys
... the passion for moving





PINTURAS

Zallys
... the passion for moving







• • • the passion for moving

Zallys srl srl - Via Palazzina 1, Sarcedo
36030 (VI) - Italia

Contatos:

sales@zallys.com
+39 0445 366785

Web site:

www.zallys.com





M6.5

Elektrische Zugmaschine

M6.5

Z194.720



4,5 km/h



400 kg



6.000 kg



15 %



- Für Lasten bis 6.000 kg.
- Lenkrad mit dem Ruder verbunden.
- Lufträder.
- Elektrische Hubfunktion optional.
- Taste zur 5-Gang-Einstellung.
- Große Auswahl an Standardkupplungen und Zubehörteile.

👁 **Vorderansicht**



👁 **Seitenansicht**



👁 **Rückansicht**



**Zollys**[®]

TABLE:

Z194.720

M6.5

Unit: mm [inch]

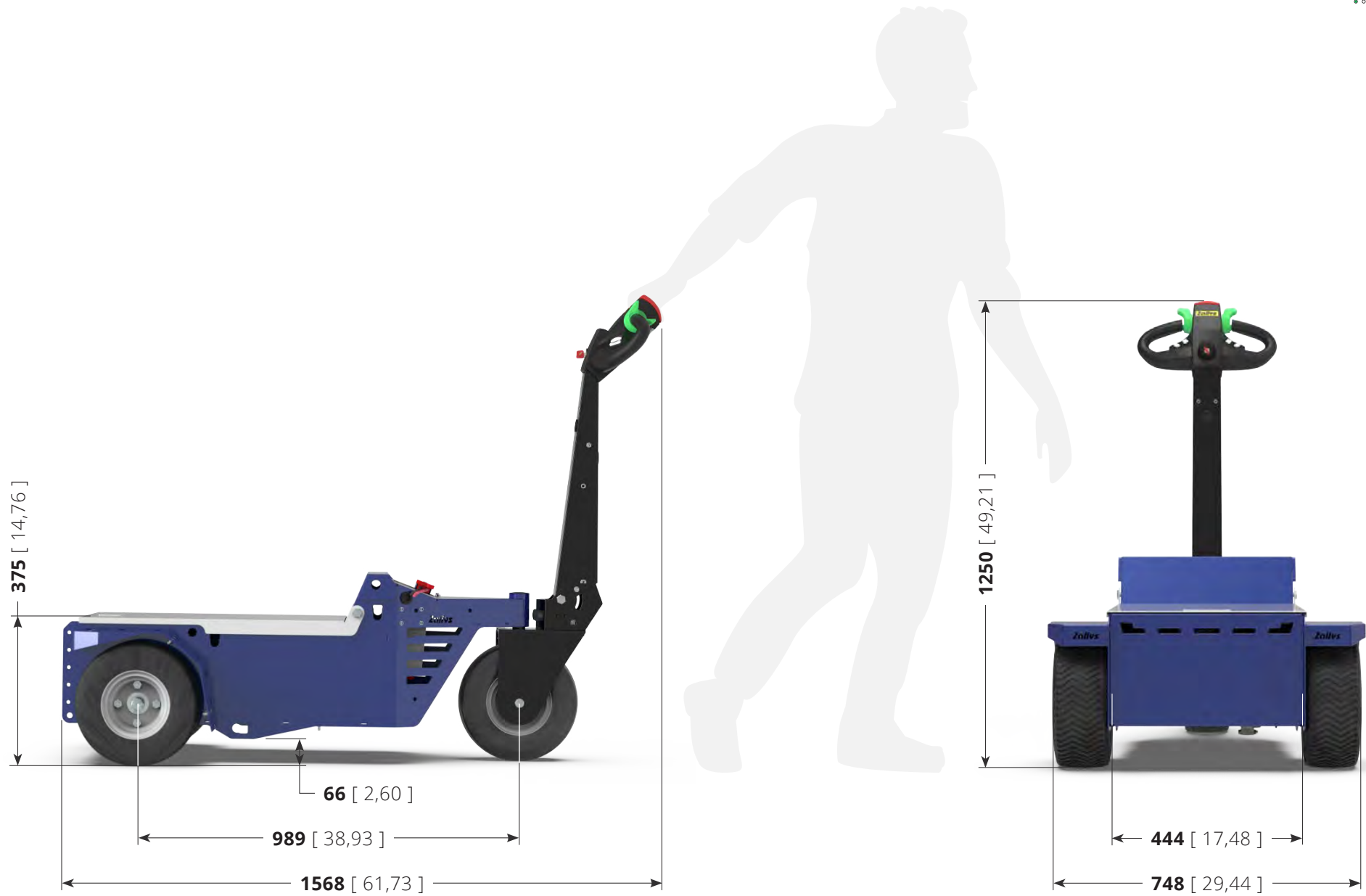
Hauptsektoren



AUTOMOBILINDUSTRIE



HUTTEN- UND
DREHINDUSTRIE



ZIMMERWERKSTATT
VERNICIATURE



GLASINDUSTRIE



FERTIGUNGSLINIEN



INTEGRIERTE LOGISTIK
& HANDELSKETTEN



FLUGHÄFEN

Schleppleistung

Bei unveränderter Hakenkraft in N kann die Zugkraft in kg **unterschiedlich sein wie folgt:**

- **Boden**-Typologie;
- Schleppnetz auf ebenem oder **geneigtem Boden**;
- Verwendung oder **Nichtverwendung von Ballast**;
- **Räder** Typologie.

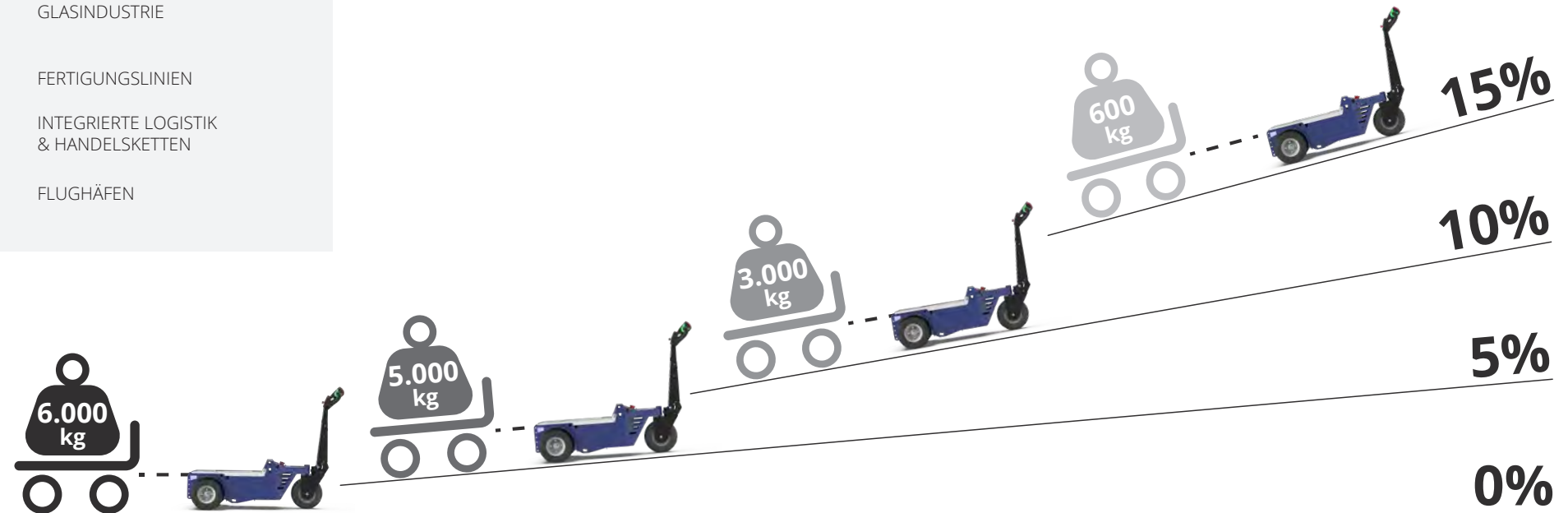

Einstellung der Geschwindigkeit in 5 Stufen

Auf dem neuen Ruder des M6.5 von Zallys finden wir **serienmäßig eine** Taste, um die Geschwindigkeit des Autos einzustellen. Mit jedem Klick gehen Sie zum nächsten Gang. Dies ermöglicht eine schnelle und bequeme Wahl der Geschwindigkeit, die der Art des zu bewältigenden Manövers angemessen ist. **Das Flex-to-Go-System** wurde entwickelt, um eine bessere Manövrierbarkeit auf engstem Raum und eine höhere Geschwindigkeit auf langen Strecken zu erreichen.

Jeder Klick erhöht die **Geschwindigkeit um 20% gegenüber** dem vorherigen Gang.

Geschwindigkeitsrampe:

20% - 40% - 60% - 80% - 100%

Sobald Sie den fünften Gang erreicht haben, drücken Sie den Knopf und kehren Sie in den ersten Gang zurück.

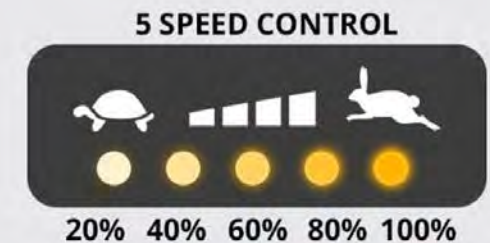

Ergonomische Führung

Der Zallys-Kopfstoß wurde entwickelt, um die Bedienung der Maschine durch den Bediener ergonomischer zu gestalten und den **richtigen Komfort bei längerer** Benutzung während der Schicht zu gewährleisten. **Das ergonomische Design** ermöglicht es Ihnen, alle Bedientasten griffbereit zu haben, das Display mit Angabe der verbleibenden Akkuladung und den Schlüssel für eine schnelle und bequeme Zündung. **Die Struktur** besteht aus **widerstandsfähigen Materialien** bei versehentlichen Stößen.

Zündschlüssel

Taste zur
5-Gang-Einstellung

Anti-
Zerquetschen Knopf



..... Bedienfeld

Taste für akustische
Warnvorrichtung

..... Dauer
betätigungseinrichtungen



Lufträder

M6.5 montiert Lufträder, die sowohl für den Einsatz im Innen- als auch im Außenbereich geeignet sind und stets eine maximale Haftung und ein sehr niedriges Vibrationsniveau gewährleisten. Darüber hinaus sind die Räder des **M6.5** kleiner als die anderen Zallys-Schlepper, um Stabilität und Traktion zu erhöhen. Das Lenkrad ist direkt mit dem Ruder verbunden, um selbst die schwersten und sperrigsten Lasten mit unglaublicher Leichtigkeit und Präzision zu bewegen.



Reichweite für einen ganzen Arbeitstag

M6.5 wird mit zwei 105/130 Ah Batterien betrieben, sie garantieren der Maschine eine **Autonomie von 8 Arbeitsstunden bei Dauereinsatz**. Bei besonders intensiver Nutzung ist es möglich, auf Batterien mit höherer Stromstärke umzusteigen oder einen herausnehmbaren und austauschbaren Akkupack zu montieren, damit die **Maschine rund um die Uhr an sieben Tagen in der Woche verfügbar ist**. In beiden Fällen sind sie einfach und sicher zu laden, dank des externen Hochfrequenz-Ladegeräts.



Modulares Ballastsystem

Das **modulare System von Zallys** bietet maximale Flexibilität bei der Steigerung der Fahrzeugleistung. **Mit einem Stückgewicht von nur 10 kg** sind die einzelnen Ballastgeräte leicht und **können ohne körperliche Anstrengung** des Bedieners ausgerüstet werden.

STANDARD HAKEN



KUGELKOPF/
STIFTKUPPLUNG



HAKEN
MIT STIFT

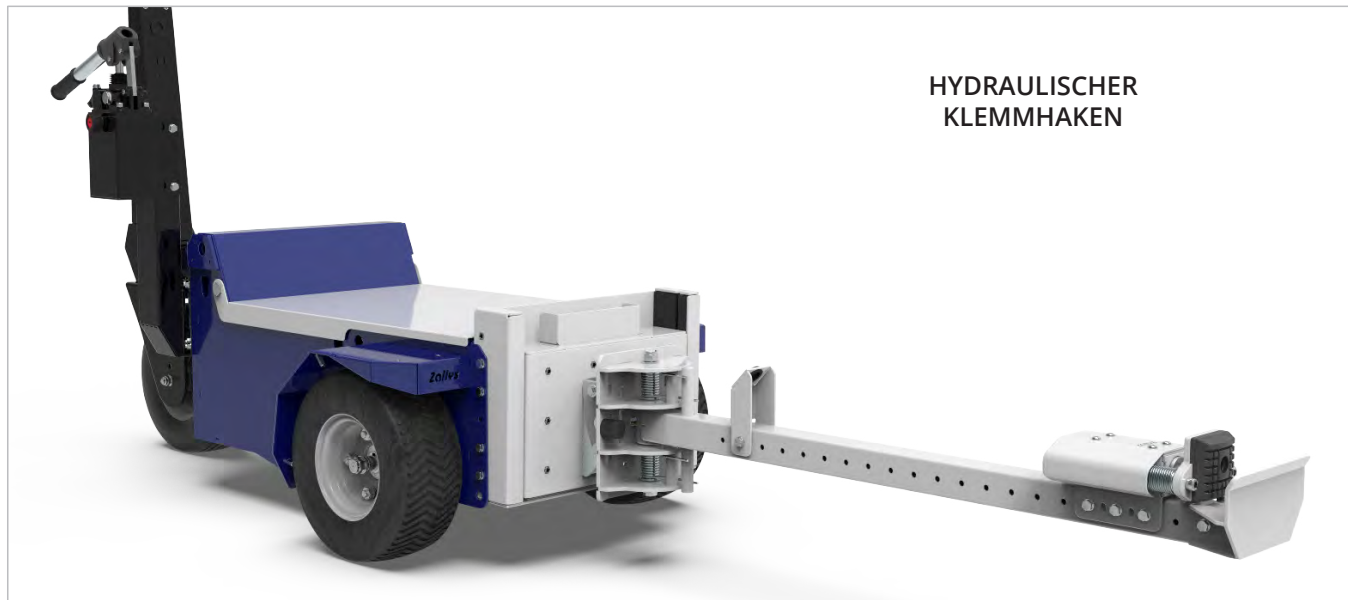

HYDRAULISCHER
KLEMMHAKEN

STANDARD HAKEN

Elektrische Hubfunktion (optional)



Auf der M6.5 kann ein **elektrisches Hebegerät** installiert werden, das es dem Bediener ermöglicht, die Zugmaschine einfach und sicher an einem 2-Rad-Anhänger zu befestigen und anzuheben, indem er die Steuerung direkt vom Ruder aus betätigt.



ZÜBEHORTEILE





Anwendungsbeispiele

in den verschiedenen Produktionssektoren



METALLINDUSTRIE

Zallys
... the passion for moving





INDUSTRIELLE WARTUNG

Zallys
... the passion for moving





LAKIEREI

Zallys
... the passion for moving



NAVAL INDUSTRIE

Zallys
... the passion for moving





• • • the passion for moving

Zallys srl srl - Via Palazzina 1, Sarcedo
36030 (VI) - Italia

Contacts:

sales@zallys.com
+39 0445 366785

Web site:

www.zallys.com

