

Zollys[®]
... the passion for moving



JACK

Trattorino elettrico industriale

JACK

Z121.732



12,0 km/h



500 kg



1.500 kg



- Versatile e compatto.
- Per trainare carichi fino a 1.500 kg e trasportare fino a 500 kg.
- Ristretto raggio di sterzata.
- Con ruote pneumatiche per uso interno ed esterno.
- Tasto per regolazione della velocità a 5 livelli.
- Vasta gamma di accessori standard o personalizzabili su richiesta.

Vista Frontale



Vista Laterale



Vista Posteriore



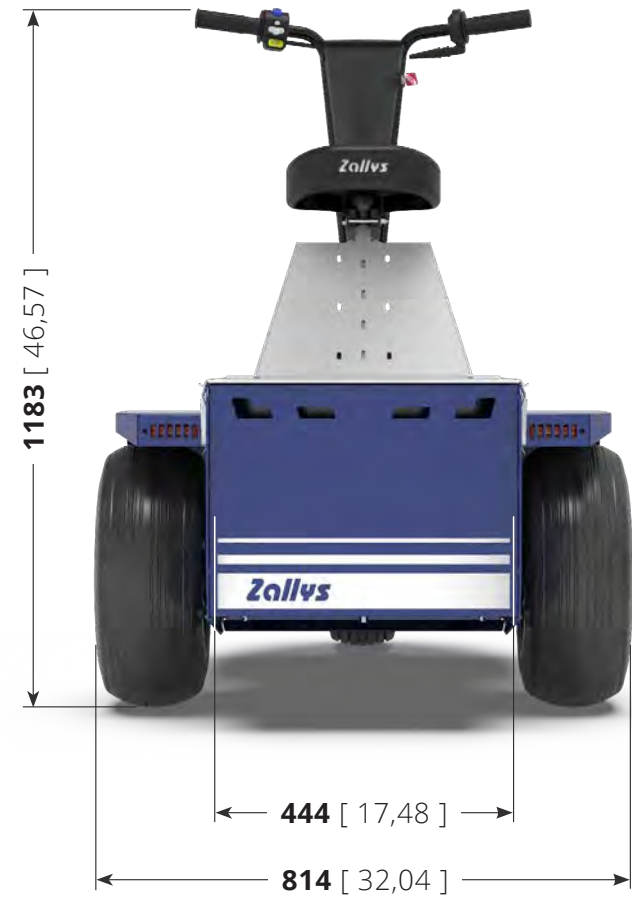
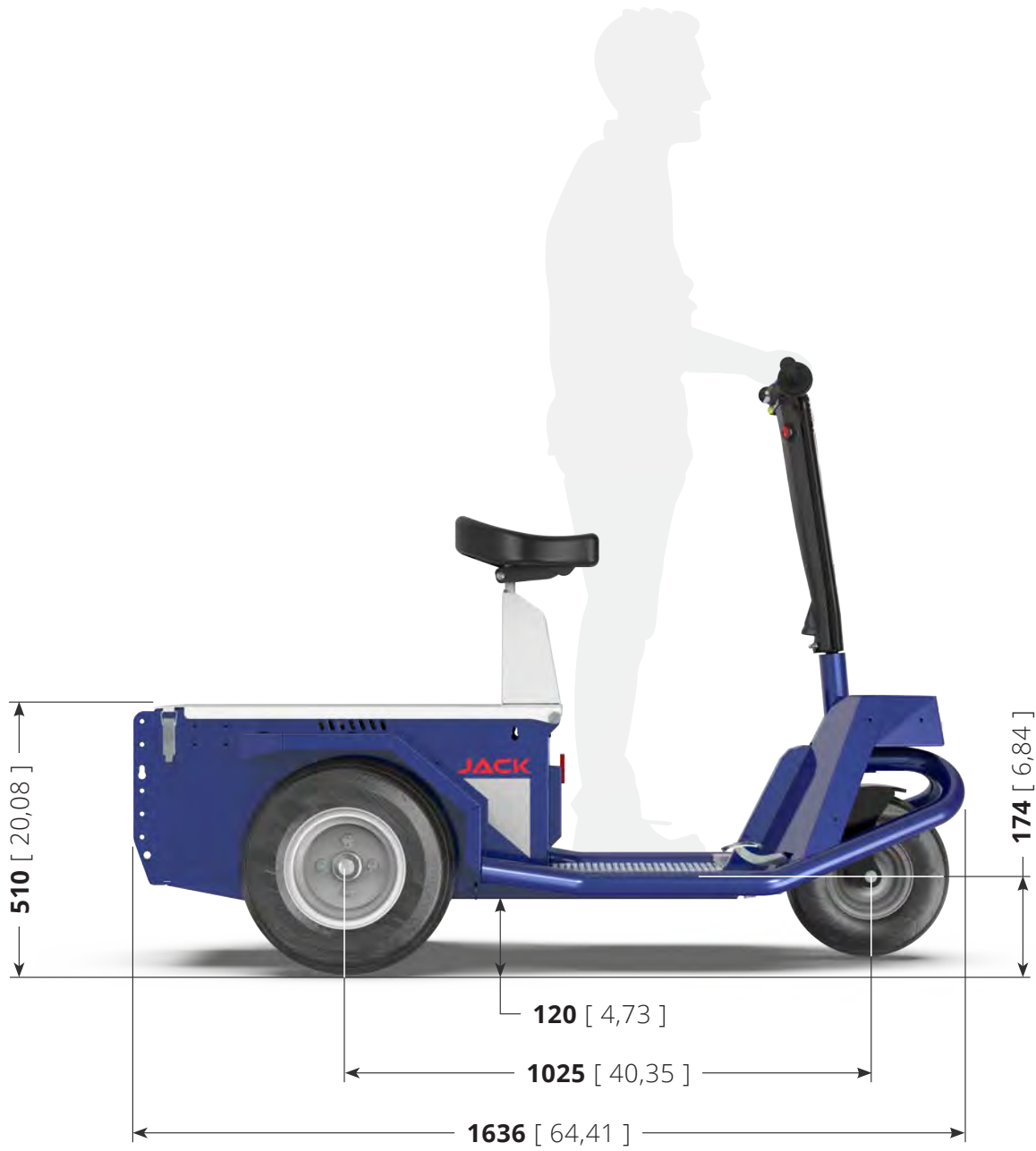

	TABLE: Z121.732	JACK	Unit: mm [inch]
--	---------------------------	-------------	-----------------

Settori principali



INDUSTRIA
AUTOMOBILISTICA



INDUSTRIA
DEL VETRO



LINEE
PRODUTTIVE



OSPEDALI



MANUTENZIONE
INDUSTRIALE





AEROPORTI

Prestazioni su pendenza

Fermo restando invariata la forza al gancio espressa in N, la capacità di traino espressa in kg e il peso del carico che può trasportare **possono variare in base a:**

- **tipo di terreno** sul quale viene effettuato il traino;
- traino su suolo **piano o in pendenza**;
- utilizzo o meno di **zavorre**;
- **tipo di ruote** montate su macchina e carrello.

 = Versione standard
 = Con Upgrade

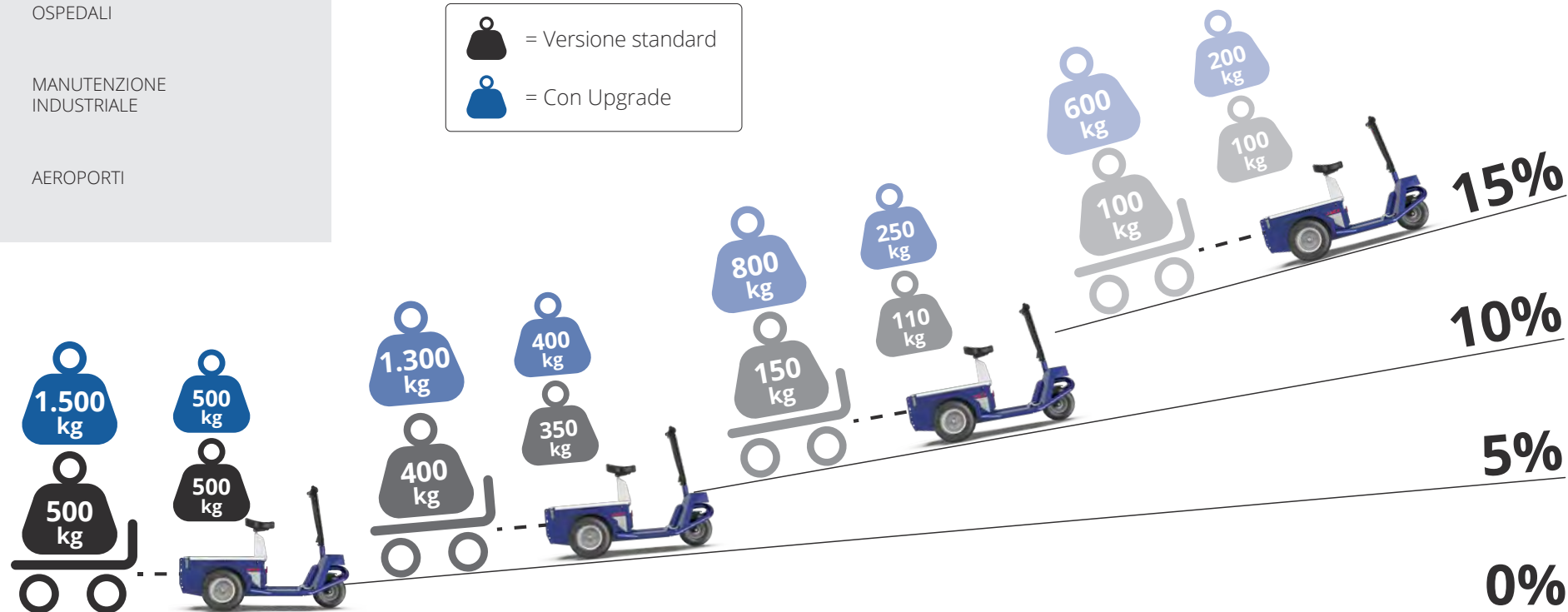

Guida ergonomica

Il manubrio di JACK è studiato per rendere più ergonomico l'utilizzo della macchina da parte dell'operatore, garantendo il giusto **comfort su un uso prolungato** durante il turno di lavoro. **Tutti i comandi sono a portata di mano**, e sul display LED sono sempre visibili la carica residua della batteria e il livello di velocità selezionato; la chiave è sul lato destro per un'accensione veloce e comoda. **La struttura** è composta da **materiali resistenti** in caso di urti accidentali.

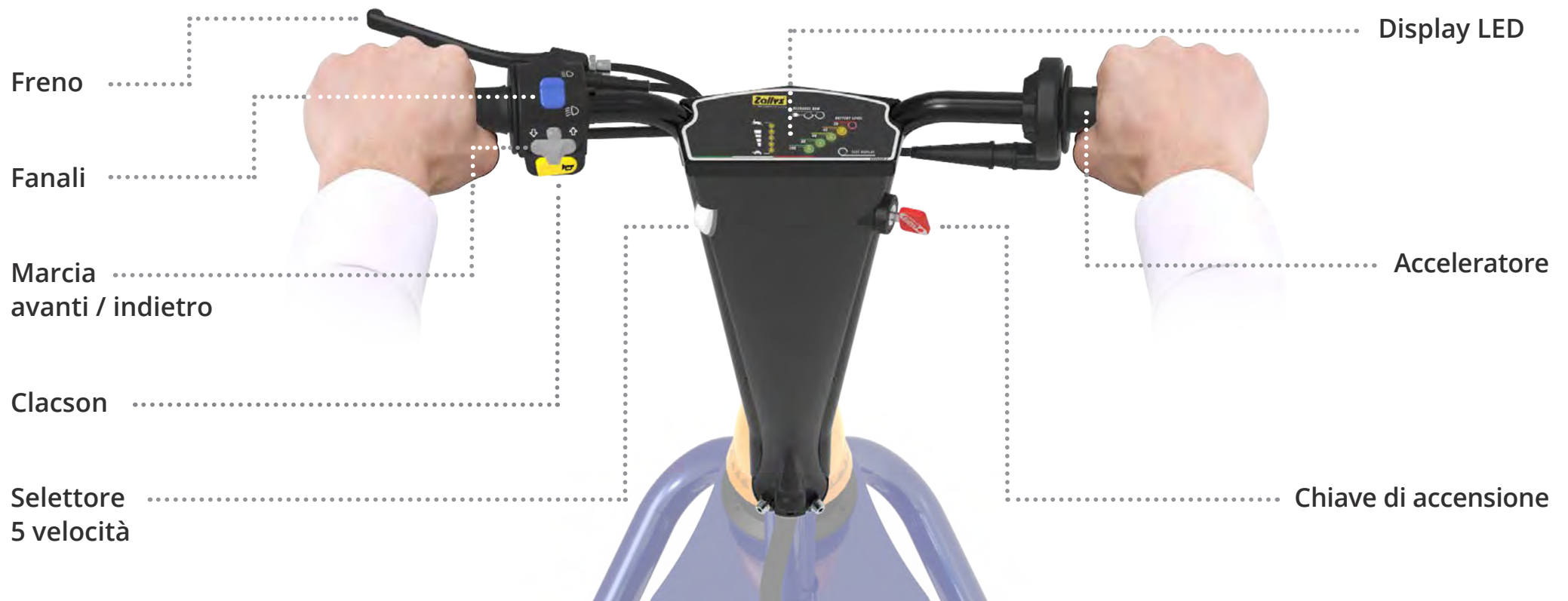



Pedale uomo
presente

Freno
meccanico

Massima sicurezza

Sulla pedana di JACK sono presenti due pedali, per garantire la massima sicurezza di utilizzo:

- **pedale uomo presente**: se non viene premuto, i comandi di guida si disattivano, evitando movimenti improvvisi e potenzialmente pericolosi quando la macchina non è in uso;
- **freno meccanico** per arrestare la macchina in caso di emergenza.



con Upgrade

Batteria di serie

Autonomia per un'intera giornata di lavoro

JACK è alimentato da due batterie da 105/130 Ah, che garantiscono alla macchina un'**autonomia di 8 ore lavorative ad uso continuativo**. Con l'**Upgrade** vengono invece montate quattro batterie da 200 / 240 Ah per garantire la stessa durata anche con le maggiori prestazioni. Grazie al caricabatterie esterno ad alta frequenza, le batterie sono facili da ricaricare.



Le ruote giuste per ogni esigenza

JACK monta di serie **ruote pneumatiche**, adatte per un utilizzo sia all'interno che all'esterno, ideale su suoli fangosi o sconnessi per garantire sempre la massima aderenza a terra e un bassissimo livello di vibrazioni. Inoltre, sono molto resistenti e offrono prestazioni eccezionali su qualsiasi terreno. Su richiesta è possibile montare altri tipi di gommatura, come ad esempio le **ruote tractor** per uso su terreni irregolari, oppure le **ruote piene "superelastiche antitraccia"**, per le pavimentazioni delicate.

GANCI STANDARD

JACK dispone di una vasta gamma di accessori per poter configurare sempre la macchina perfetta a seconda delle necessità del cliente, come ad esempio **cesti** di varie misure per il trasporto di materiali, varie tipologie di **ganci** per il traino e accessori per aumentare la sicurezza, come **girofarì lampeggianti** e **carter di protezione**.



ACCESSORI

Visibilità in ogni tipo di ambiente

JACK è dotato di serie di **luci LED anteriori e posteriori**, per guidare anche in quegli ambienti in cui non è sempre garantito un livello d'illuminazione adeguato, e di un **girofarò anteriore** per segnalare la propria posizione.



ACCESSORI

Massima agilità per un utilizzo più efficiente

La **pedana di JACK** è posizionata ad un'altezza minima da terra, per rendere più rapide e sicure la salita e la discesa dal veicolo, **riducendo così i tempi** per le operazioni ed **aumentando la produttività**. È inoltre possibile applicare, al posto della sella, un comodo **schienale ergonomico** per ridurre l'affaticamento durante gli spostamenti più lunghi.





Esempi di applicazione

nei vari settori produttivi



MANUTENZIONE INDUSTRIALE

Zollys
the passion for moving



INDUSTRIA DEL VETRO

Zallys®
... the passion for moving





AEROPORTI

Zallys[®]

... the passion for moving





INDUSTRIA TESSILE

Zollis®
... the passion for moving





LOGISTICA DEI RIFIUTI

Zollis
... the passion for moving





MANUTENZIONE DEL VERDE

Zollis
... the passion for moving



★ APPLICAZIONI SPECIALI



Zollis CE
www.zollis.com
131112



• • • the passion for moving

Zallys srl srl - Via Palazzina 1, Sarcedo
36030 (VI) - Italia

Contatti:

sales@zallys.com
+39 0445 366785

Web site:

www.zallys.com



The word "JACK" is printed in a large, bold, red, sans-serif font on a blue, metallic-looking surface. The letters are slightly shadowed, giving them a three-dimensional appearance. The background is a close-up of a blue metal structure, possibly part of a truck or trailer, with some rivets and a black rectangular component visible.

Zollys[®]
... the passion for moving



JACK

Electric tow tractor

JACK

Z121.732



12,0 km/h



500 kg



1.500 kg



- Can tow loads up to 1.500 kg and load up to 500 kg.
- Versatile and compact.
- Short steering radius.
- Pneumatic wheels for both indoor and outdoor use.
- 5-levels speed adjustment.
- Wide range of accessories and connections.

👁 **Front View**



👁 **Side View**



👁 **Rear View**



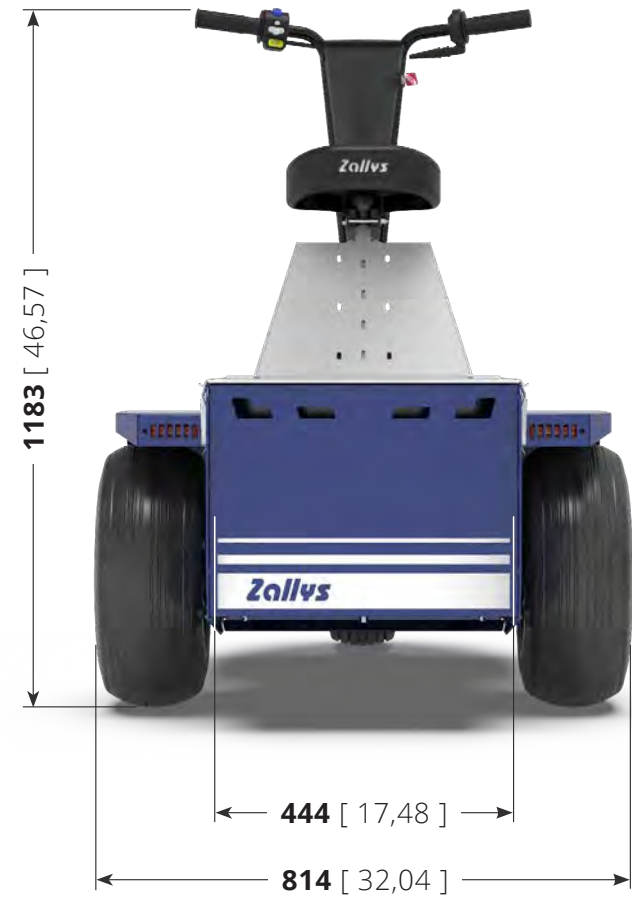
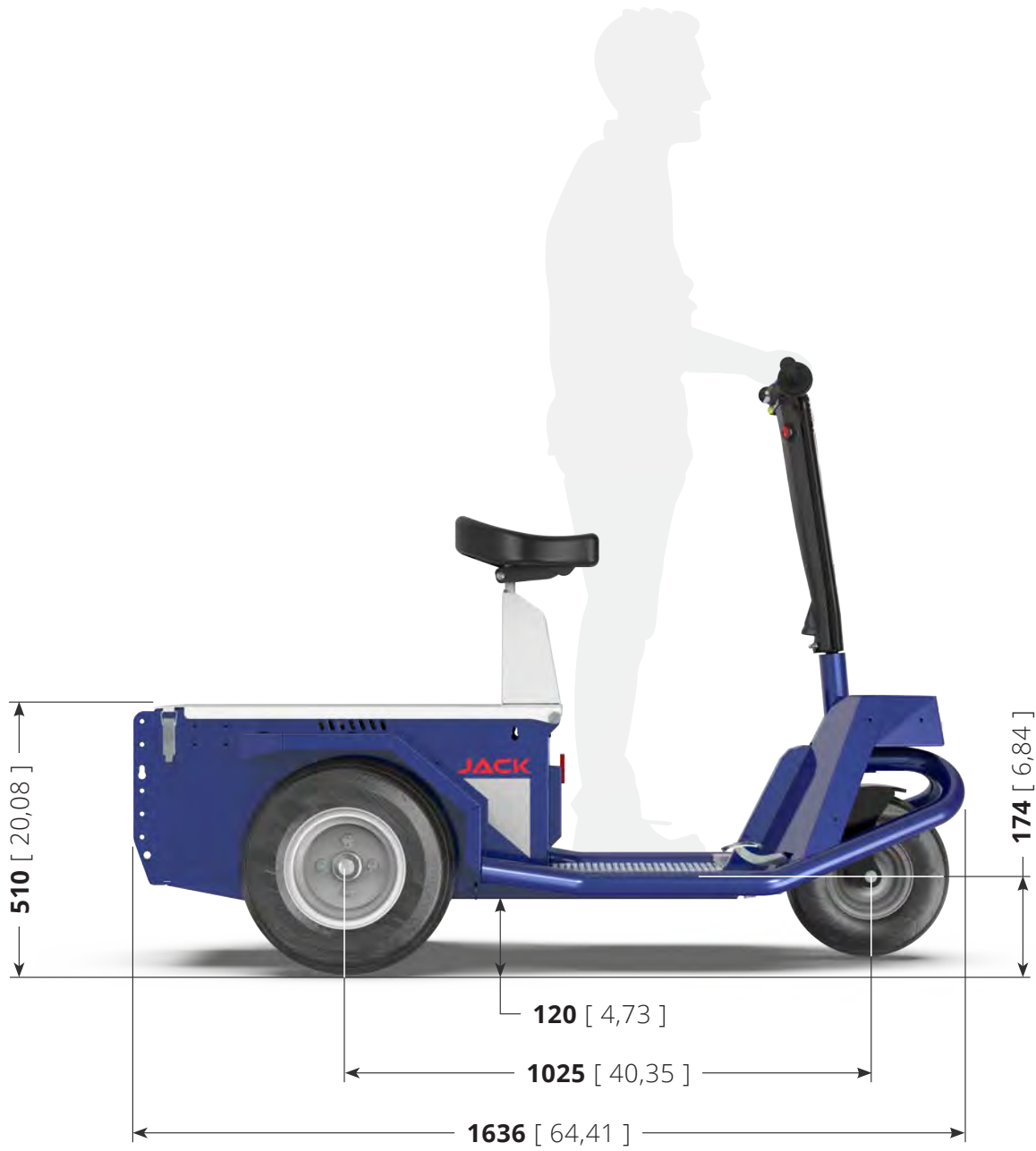

	TABLE: Z121.732	JACK	Unit: mm [inch]
--	---------------------------	-------------	-----------------

Main sectors



AUTOMOTIVE INDUSTRY



GLASS INDUSTRY



PRODUCTION LINES



HOSPITALS



INDUSTRIAL MAINTENANCE





AIRPORTS

Performances on slopes

While the force expressed in N at the hook remains unchanged, **the towing capacity expressed in kg and the load capacity may vary based on:**

- **type of ground** on which the towing is performed;
- towing on **flat ground or on a slope**;
- use (or not) of **ballasts**;
- **type of wheels** mounted on the vehicle and on the trailer.

 = Standard version
 = With Upgrade

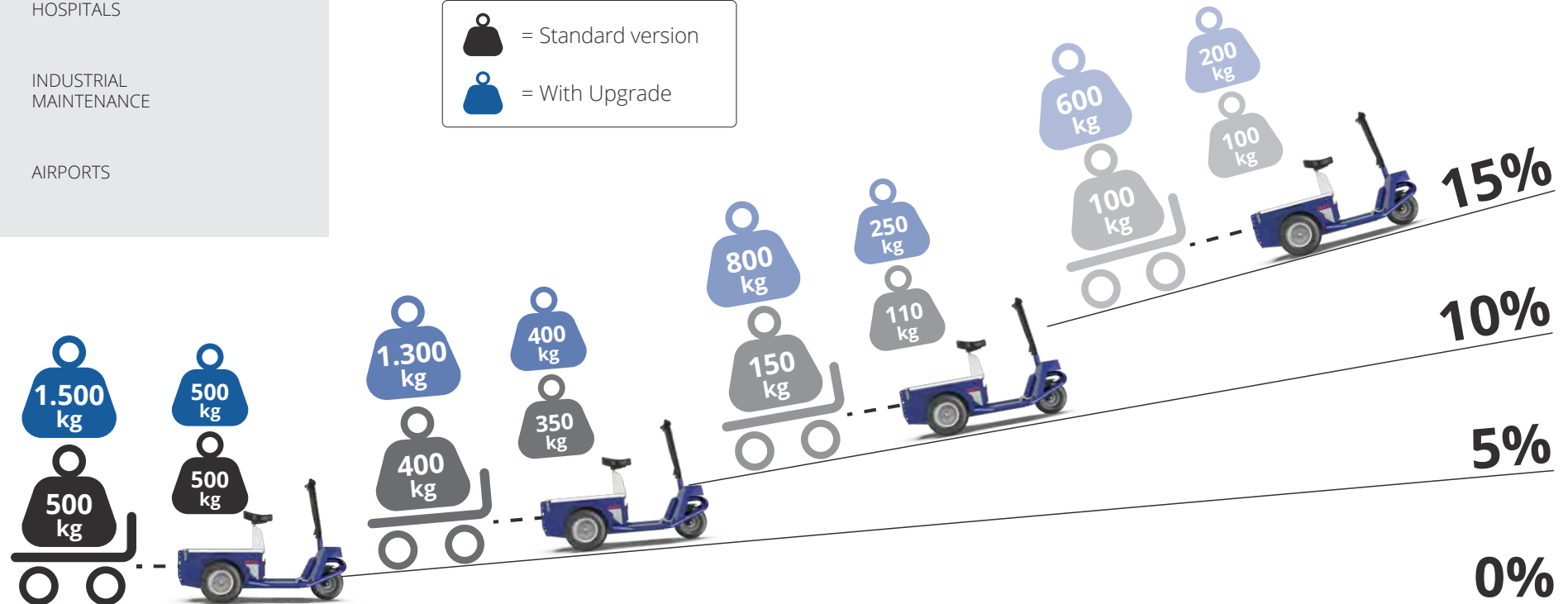

Ergonomic driving

JACK's handlebar is studied to make the use of the machine more ergonomic and to guarantee great **comfort on a prolonged use** during the work shift. **All the driving controls are at your fingertips**, and on the LED display are always visible the battery charge level and the selected speed; the power key is on the right for an easy and fast ignition. **The structure** is made of **resistant materials** in case of accidental bumps.

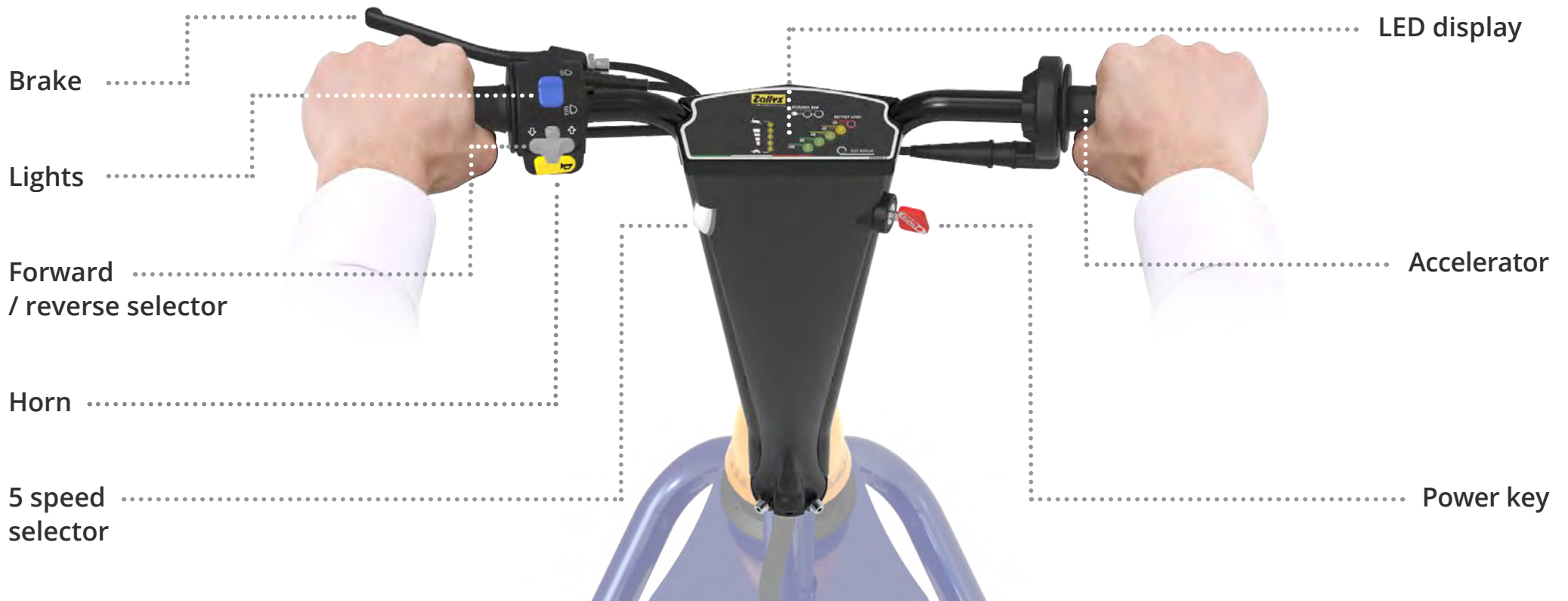



Maximum security

On JACK's footboard there are two pedals, to guarantee the maximum security during the use:

- "dead-man" pedal: if not pressed, the driving controls are inactive, avoiding sudden and potentially dangerous movements when the machine is not in use;
- mechanical brake to stop the machine in case of emergency.



Autonomy for a full working day

JACK is powered by two 105/130 Ah batteries, which guarantee the machine for **8 continuative working hours operation**. By purchasing the Upgrade, four 200 / 240 Ah batteries will be mounted in order to guarantee the same duration even with the improved performances. Thanks to the high frequency external battery charger, the batteries are easy to charge.



The right wheels for every need

JACK mounts **pneumatic wheels** as standard, suitable for both indoor and outdoor use, and guarantee the maximum grip and a very low level of vibrations. Moreover, they are really resistant and offer exceptional performances on every terrain. On request it is possible to put on a different kind of wheels, such as **Tractor wheels** for irregular or uneven terrains, or the "**non-marking superelastic**" wheels, for delicate floorings.

STANDARD HITCHES

JACK has a variety of accessories that can be equipped, to always configure the machine that meets the client's needs, such as **baskets** in various sizes for the transport of materials, several typologies of **hitches** for towing and accessoriesto increase security, such as **flashing beacons and protection carters**.



ACCESSORIES

Visibility in every work environment

JACK has **front and rear LED lights**, to drive even in those environments in which a correct lighting level is not always guaranteed, and a **flashing beacon** to indicate the position.



ACCESSORIES

Maximum agility for a more efficient use

JACK's footboard is positioned at a minimum height from the ground, so stepping on and off the machine is quick and safe, **reducing operation time and increasing productivity**. On request, it is possible to equip a **comfortable backrest** in place of the seat in order to reduce the fatigue during longer journeys.





Examples of applications

on various production sectors



INDUSTRIAL MAINTENANCE

Zollus
the passion for moving



GLASS INDUSTRY

Zallys
... the passion for moving





AIRPORTS

Zallys
... the passion for moving





TEXTILE INDUSTRY

Zollis®
... the passion for moving





WASTE LOGISTICS

Zollis
... the passion for moving





GREEN MAINTENANCE

Zollis
... the passion for moving



★ SPECIAL APPLICATIONS

Zollis
... the passion for moving



Zollis CE
www.zollis.com
131112



• • • the passion for moving

Zallys srl srl - Via Palazzina 1, Sarcedo
36030 (VI) - Italia

Contacts:

sales@zallys.com
+39 0445 366785

Web site:

www.zallys.com



The word "JACK" is printed in a large, bold, red, sans-serif font on a blue, metallic-looking surface. The letters are slightly shadowed, giving them a three-dimensional appearance. The background is a close-up of a blue metal structure, possibly part of a truck or trailer, with some rivets and a black rectangular component visible.

Zollys[®]
... the passion for moving



JACK

Tracteur électrique avec conducteur

JACK

Z121.732



12,0 km/h



500 kg



1.500 kg



- Pour tracter des charges jusqu'à 1500 kg et transporter jusqu'à 500 kg.
- Polyvalent et compact.
- Rayon de braquage étroit.
- Avec roues pneumatiques pour une utilisation intérieure et extérieure.
- Bouton pour le réglage de la vitesse.
- Large gamme d'accessoires standard ou personnalisable sur demande.

👁️ **Vue de face**



👁️ **Vue latérale**



👁️ **Vue arrière**



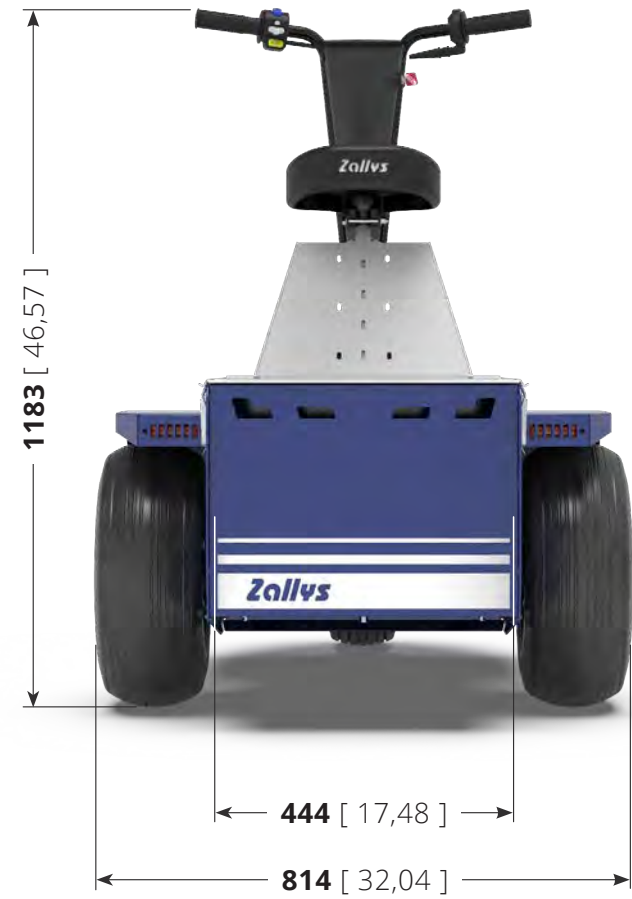
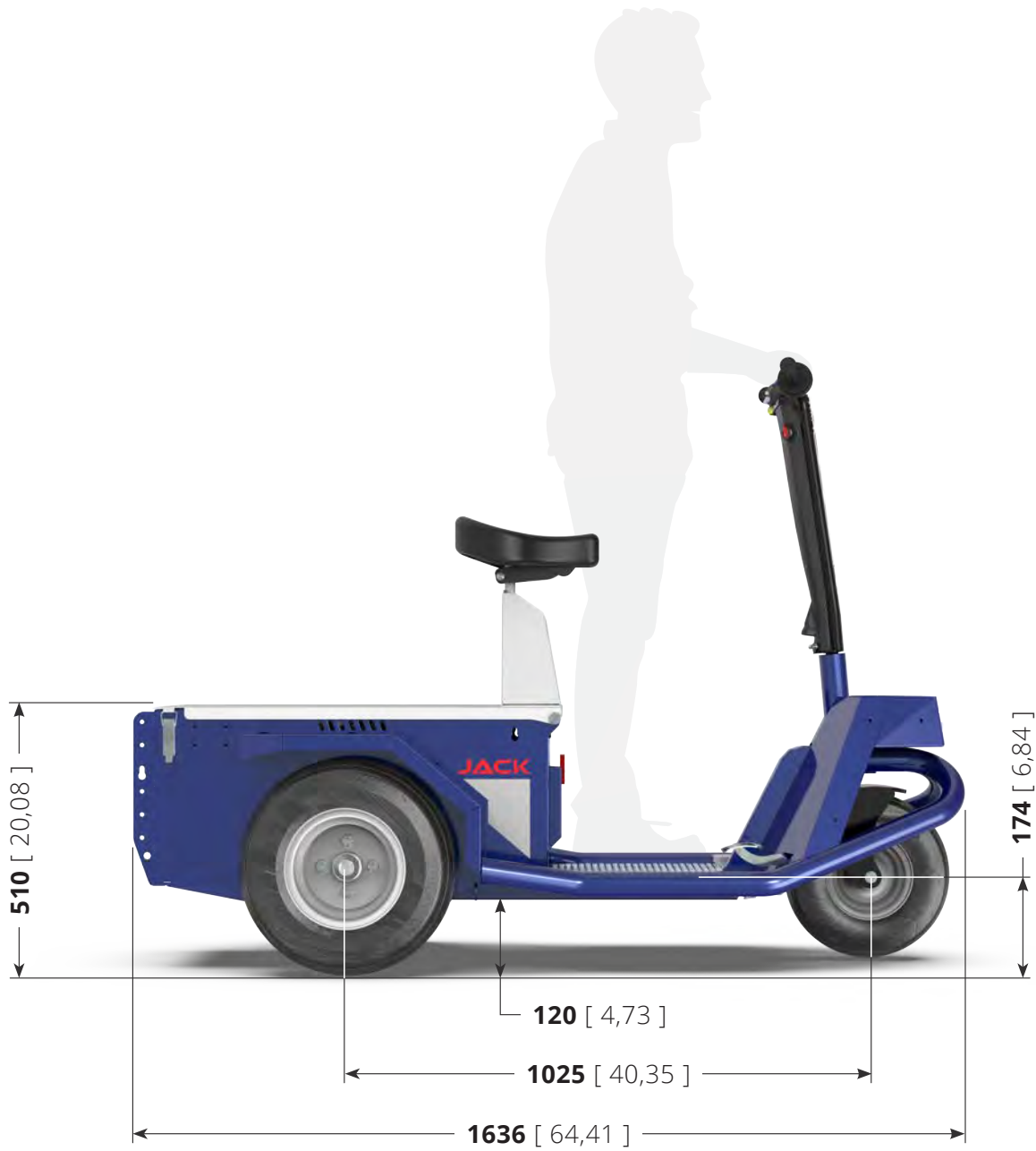

	TABLE: Z121.732	JACK	Unit: mm [inch]
--	---------------------------	-------------	-----------------

Principaux secteurs



INDUSTRIE
AUTOMOBILE



INDUSTRIE
DU VERRE



LIGNES DE
PRODUCTION



HÔPITAUX



MAINTENANCE
INDUSTRIELLE



AÉROPORTS

Performances en pente

Compte tenu des valeurs standard de l'effort de traction max au crochet en N, de la capacité de traction en kg et du poids qu'on peut charger, les performances en pente peuvent varier suite à:

- **type de sol** où on travaille;
- traction sur **plan or en pente**;
- utilisation ou pas de **lests**;
- **typologies de roues** de la machine et du chariot.



= Standard



= Avec Upgrade

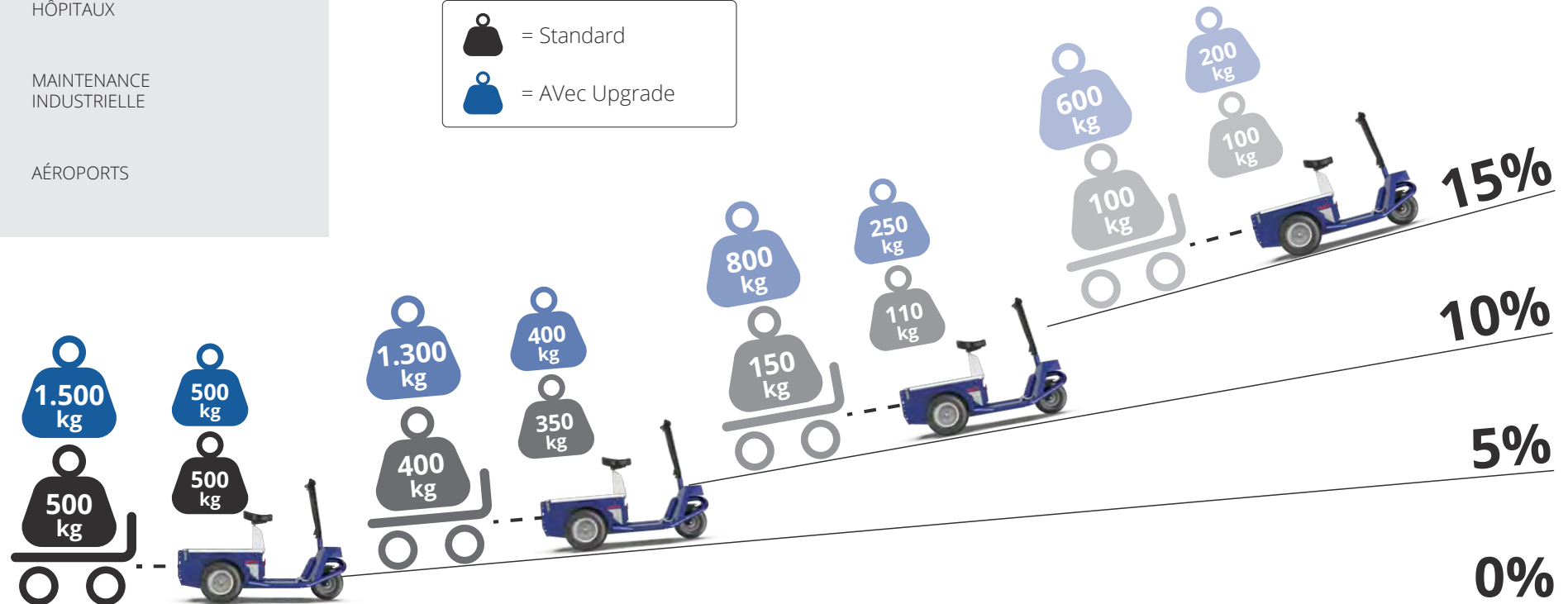

Conduite ergonomique

La conduite avec guidon du Jack L est pensée pour rendre l'utilisation de la brouette la plus ergonomique possible pour l'opérateur, en garantissant le **correct comfort** pendant un usage prolongé sur le lieu du travail. **Toutes les commandes à portée de main**: dans le tableau de bord, des voyants à LED sont toujours visibles, le niveau de charge et la vitesse sélectionnée; la clé se trouve sur la côté droite, pour un allumage vite et facile. La structure est faite avec **matériaux résistants** aux chocs accidentels.

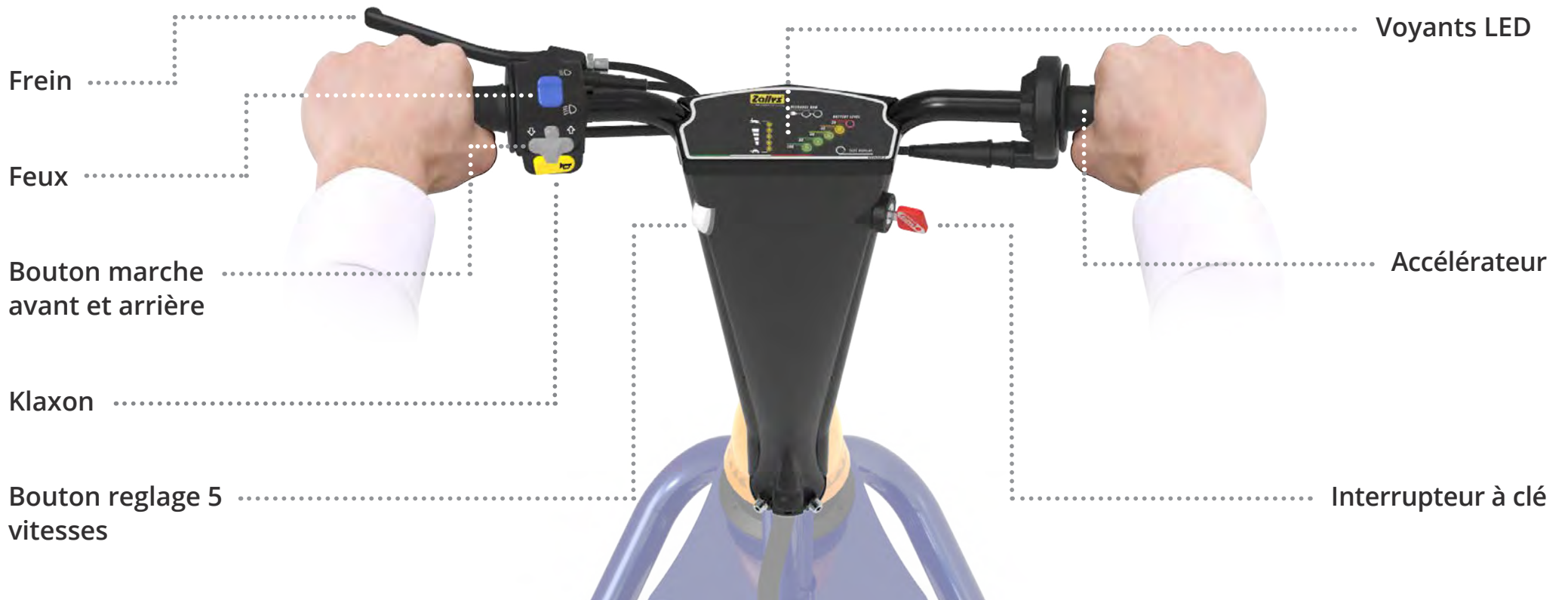



Pédalier
"homme mort"

Frein
mécanique

Sécurité maximale

2 pédaliers se trouvent sur l'estrade du JACK, afin de garantir une grande sûreté pendant l'utilisation:

- **pédalier "homme mort"** : si l'opérateur ne l'appuie pas, les commandes de conduite se coupent, en évitant mouvements brusques et dangereux;
- **frein mécanique** pour stopper la machine en cas d'urgence



avec Upgrade

Batteries en standard

Autonomie des batteries pour toute la journée

JACK fonctionne avec 2 batteries AGM 105 / 130 Ah, elles permettent de travailler pour **8 heures en continu**. En choisissant le modèle avec **Upgrade**, on installe 4 batteries 200 / 240 Ah pour garantir la même durée, mais avec meilleures performances. Grâce au chargeur extérieur à haute fréquence, les batteries peuvent être chargées très facilement.



Le ruote giuste per ogni esigenza

JACK monta di serie **ruote pneumatiche**, adatte per un utilizzo sia all'interno che all'esterno, ideale su suoli fangosi o sconnessi per garantire sempre la massima aderenza a terra e un bassissimo livello di vibrazioni. Inoltre, sono molto resistenti e offrono prestazioni eccezionali su qualsiasi terreno. Su richiesta è possibile montare altri tipi di gommatura, come ad esempio le **ruote tractor** per uso su terreni irregolari, oppure le **ruote piene "superelastiche antitraccia"**, per le pavimentazioni delicate.

CROCHETS STANDARD

JACK bénéficie d'une large gamme des accessoires pour configurer la machine parfaite selon les besoins des clients: beaucoup de **paniers** et plateaux de plusieurs dimensions, différentes typologies des attelages pour tracter et des équipements pour augmenter la sécurité, les **gyrophares** et les **parachocs antérieurs**.



ACCESSOIRES

Plateaux et cuves pour toute exigence

JACK est équipé avec des **feux avant et arrière aux LED**, pour se déplacer sans problèmes aussi où l'éclairage n'est pas optimal, et d'un **gyrophare** afin de signaler sa propre position.



ACCESSOIRES

Agilité maximale pour une utilisation plus efficace

La **marche** d'accès basse offre à l'utilisateur une grande aisance de mouvement, rend plus vite et sûr monter et descendre de la machine, en **réduisant de cette façon la durée des opérations et en accroissant la productivité**. Il est également possible d'équiper la machine, au lieu de la siége, avec un **dossier ergonomique** et pratique, il aide bien à réduire la fatigue pendant les déplacements plus loins.

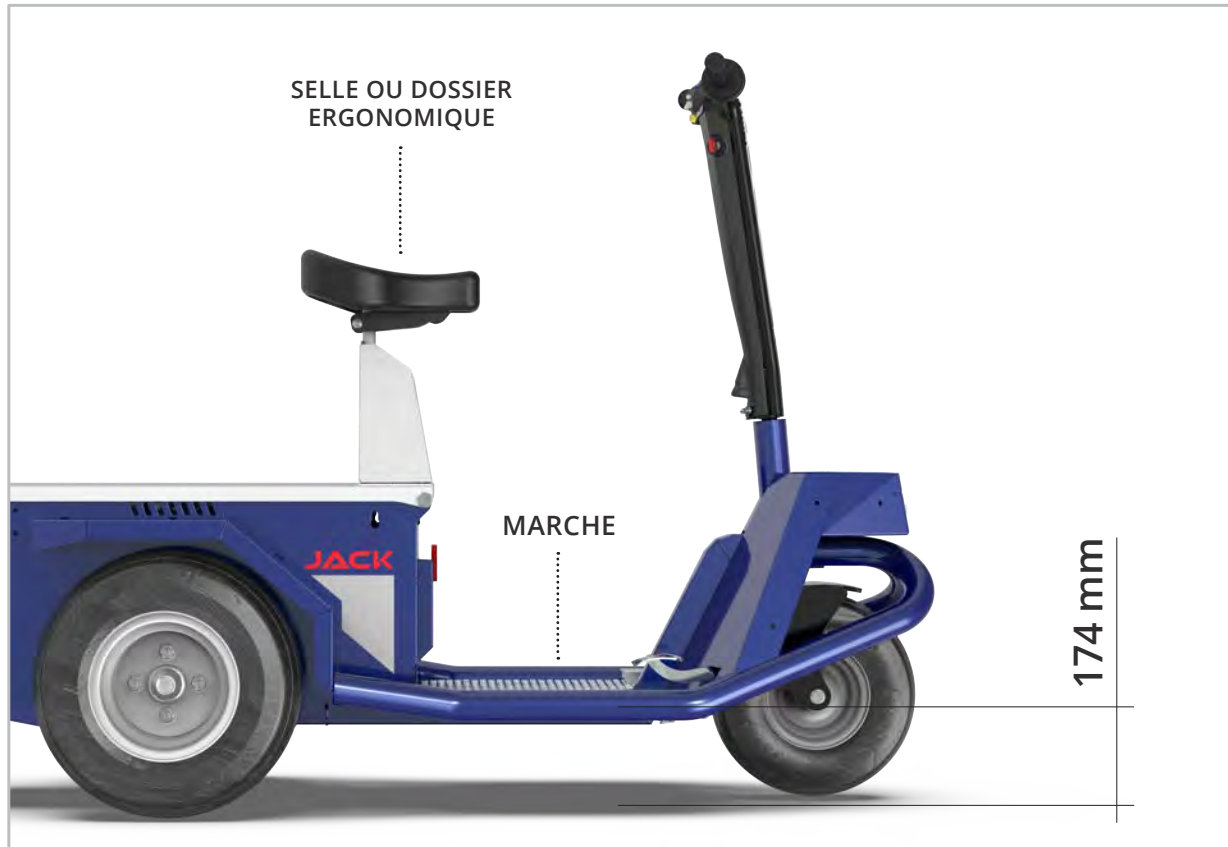



Exemples d'applications

Dans les différents secteurs productifs



MAINTENANCE INDUSTRIELLE

Zollys
the passion for moving







AÉROPORTS

Zallys
... the passion for moving





INDUSTRIE DU TEXTILE

Zollis®
... the passion for moving





LOGISTIQUE DES DÉCHETS

Zolllys
... the passion for moving





ENTRETIEN ESPACE VERTS

Zollis
... the passion for moving





APPLICATIONS PARTICULIÈRES



Zollis CE
www.zollis.com
131112



• • • the passion for moving

Zallys srl srl - Via Palazzina 1, Sarcedo
36030 (VI) - Italia

Contatti:

sales@zallys.com
+39 0445 366785

Web site:

www.zallys.com



The word "JACK" is printed in a large, bold, red, sans-serif font on a glossy blue surface. The letters are slightly shadowed, giving them a three-dimensional appearance. The background shows the metallic texture of the surface and some mechanical details like a bolt and a small black rectangular component.

Zollys[®]
... the passion for moving



JACK

Tractor de remolque

JACK

Z121.732



12,0 km/h



500 kg



1.500 kg



- Versátil y compacto.
- Para remolcar cargas de hasta 1.500 kg e trasportare fino a 500 kg.
- Estrecho radio de giro.
- Con ruedas neumáticas para uso interior y exterior.
- Botón de ajuste de velocidad de 5 niveles.
- Amplia gama de accesorios estándar o personalizables bajo pedido.

👁 Vista Frontal



👁 Vista Lateral



👁 Vista Trasera



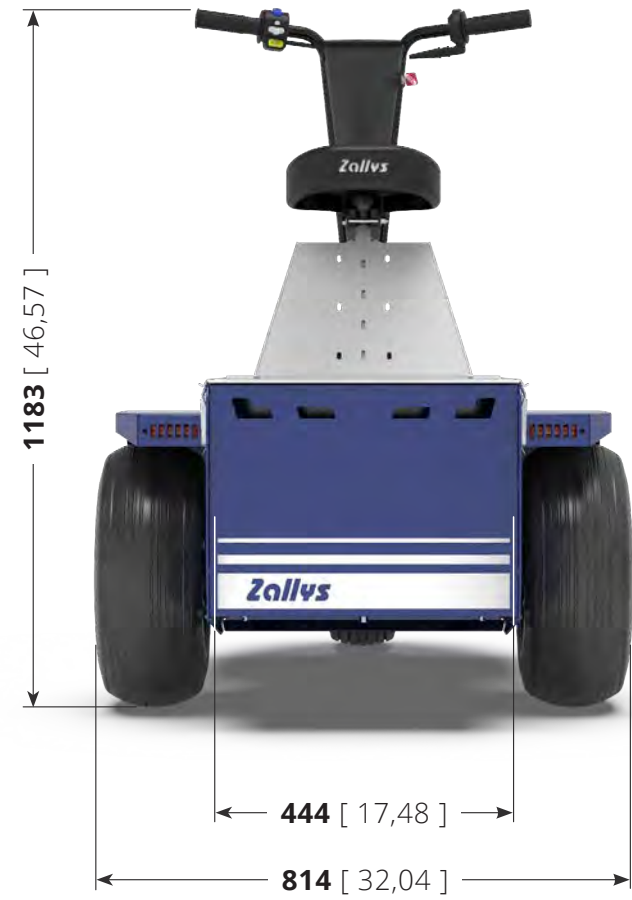
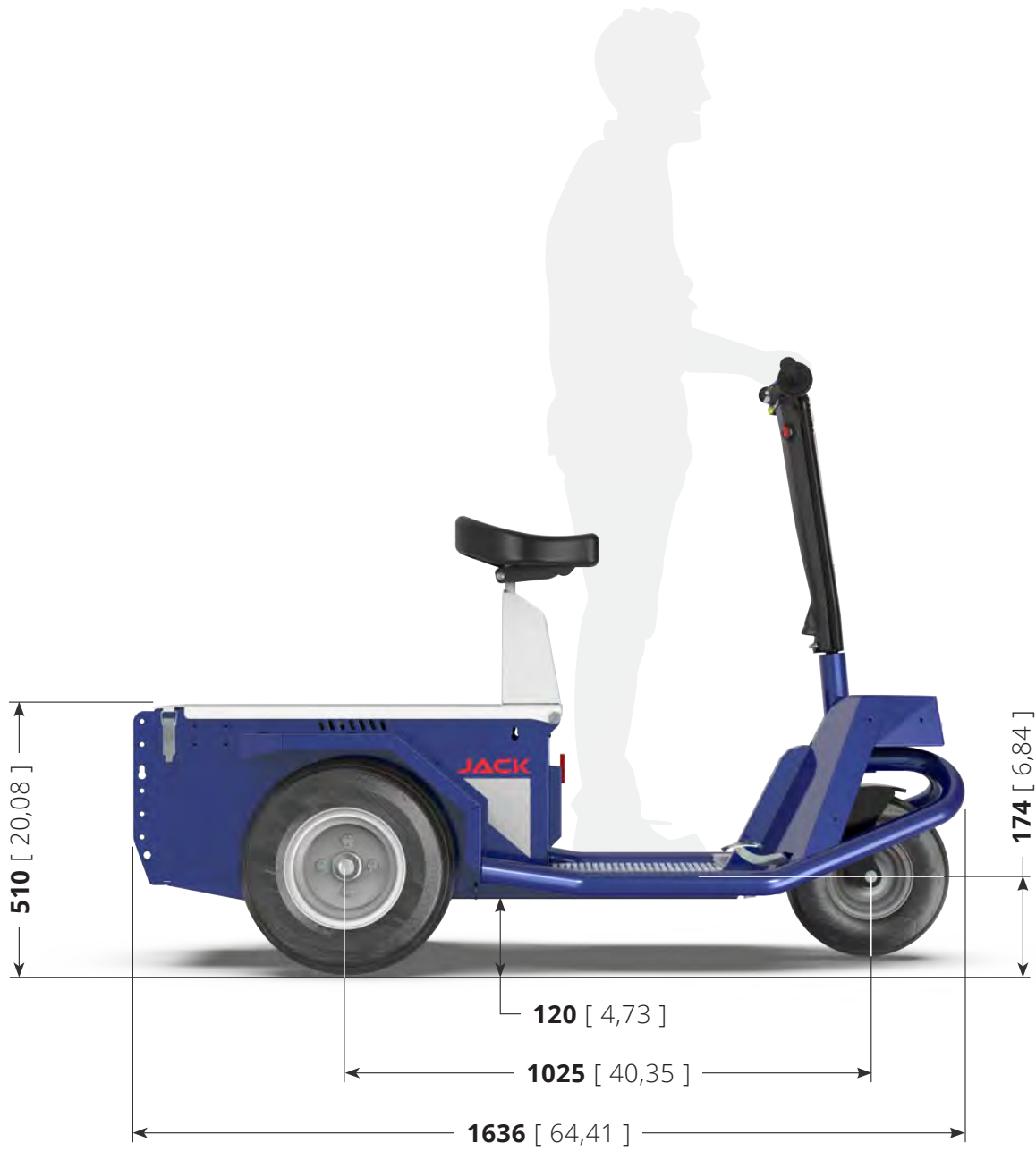

	TABLE: Z121.732	JACK	Unit: mm [inch]
--	---------------------------	-------------	-----------------

Sectores principales



INDUSTRIA AUTOMOTRIZ



INDUSTRIA DEL VETRO



LÍNEAS DE PRODUCCIÓN



HOSPITALES



MANTENIMIENTO INDUSTRIAL





AEROPUERTOS

Rendimiento en pendiente

Sin perjuicio de la fuerza sobre el gancho expresada en N, la capacidad de remolque expresada en kg y el peso de la carga que puede transportar **pueden variar según:**

- **tipo de terreno** en el que se hace el remolque;
- remolque en terreno **llano o inclinado**;
- uso o no de **contrapesos**;
- **tipo de ruedas** montadas en la máquina y carro.

 = Versión estándar
 = Con Upgrade

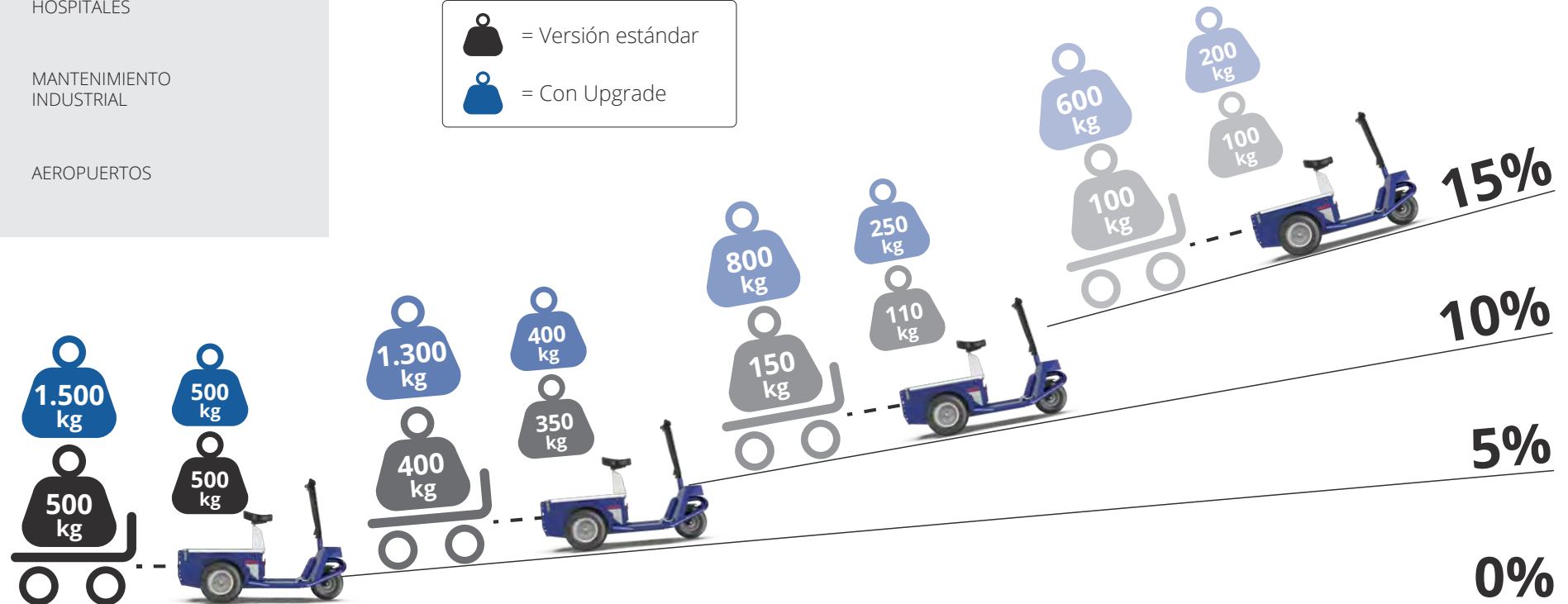

Conducción ergonómica

El manillar de JACK está diseñado para hacer más ergonómico el uso de la máquina por parte del operador, garantizando la **comodidad adecuada en un uso prolongado** durante el turno de trabajo. **Todos los controles están al alcance de la mano**, en su pantalla Led siempre son visibles la carga restante de la batería y el nivel de velocidad seleccionado; la llave está en el lado derecho para un encendido rápido y conveniente. La **estructura** está fabricada con **materiales resistentes** en caso de impactos accidentales.

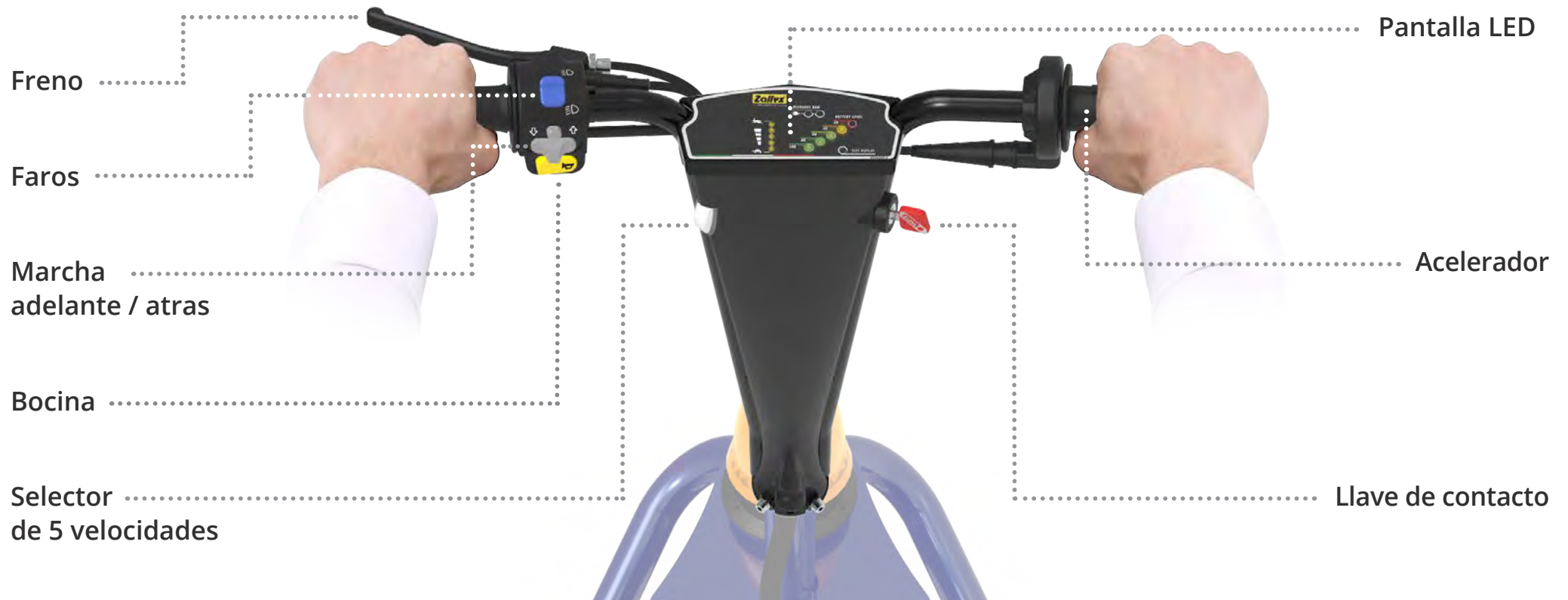

Pedal de
hombre muertoFreno
mecánico

Máxima seguridad

En la **plataforma JACK** hay dos pedales, para garantizar la máxima seguridad de uso:

- **pedal de hombre muerto:** si no se presiona, los mandos de conducción se desactivan, evitando movimientos bruscos y potencialmente peligrosos cuando la máquina no está en uso;
- **Freno mecánico** para detener la máquina en caso de emergencia.



con Upgrade

Baterías de serie

Autonomía para todo un día de trabajo

JACK funciona con dos baterías de 105/130 Ah, que garantizan a la máquina una autonomía de **8 horas de trabajo para uso continuo**. En cambio, con la actualización, se instalan cuatro baterías de 200/240 Ah para garantizar la misma duración incluso con un rendimiento superior. Gracias al cargador externo de alta frecuencia, las baterías son fáciles de recargar.

Las ruedas adecuadas para cada necesidad



JACK está equipado de serie con **ruedas neumáticas**, aptas tanto para uso interior como exterior, ideales en terrenos embarrados o desnivelados para asegurar siempre la máxima adherencia al suelo y un nivel muy bajo de vibraciones. Además, son muy duraderas y ofrecen un rendimiento excepcional en cualquier terreno. Bajo pedido es posible montar otros tipos de neumáticos, como **ruedas de tractor** para uso en terreno irregular, o **ruedas macizas "superelásticas que no dejan huella"**, para suelos delicados.

GANCHOS ESTÁNDAR

JACK dispone de una amplia gama de accesorios para configurar siempre la máquina perfecta según las necesidades del cliente, como **cestas de varios tamaños** para el transporte de materiales, varios tipos de **ganchos** de remolque y accesorios para aumentar la seguridad, como **faro giratorio intermitentes** y **carter de protección**.



ACCESORIOS

Visibilidad en cualquier tipo de entorno

JACK está equipado de serie con **luces LED delanteras y traseras**, para conducir incluso en aquellos entornos donde no siempre se garantiza un nivel de iluminación adecuado, y con un **faro giratorio delantero** para señalar tu posición.



ACCESORIOS

Máxima agilidad para un uso más eficiente

La **plataforma JACK** está colocada a una altura mínima del suelo, para que subir y bajar del vehículo sea más rápido y seguro, **reduciendo así el tiempo** de operaciones y **aumentando la productividad**. También es posible aplicar, en lugar del sillín, un cómodo **respaldo ergonómico** para reducir la fatiga durante los viajes más largos.





Ejemplos de aplicación

en los distintos sectores productivos



MANTENIMIENTO INDUSTRIAL

Zollys
the passion for moving





INDUSTRIA DEL VIDRIO

Zallys
... the passion for moving





AEROPUERTOS

Zallys
... the passion for moving





INDUSTRIA TEXTIL

Zollis
... the passion for moving





LOGÍSTICA DE RESIDUOS

Zollis
... the passion for moving





MANTENIMIENTO VERDE

Zollis
... the passion for moving





APLICACIONES ESPECIALES

Zollis
... the passion for moving



Zollis CE
www.zollis.com
131112



• • • the passion for moving

Zallys srl srl - Via Palazzina 1, Sarcedo
36030 (VI) - Italia

Contatos:

sales@zallys.com
+39 0445 366785

Web site:

www.zallys.com



The word 'JACK' is printed in a large, bold, red, sans-serif font on a glossy blue surface. The letters are slightly shadowed, giving them a three-dimensional appearance. The background is a close-up of a blue metal or plastic structure, possibly part of a vehicle or machinery, with some white components visible at the top.

Zollys[®]
... the passion for moving



JACK

Elektroplattformwagen

JACK

Z121.732



12,0 km/h



500 kg



1.500 kg



- Für Lasten bis 1500 kg ziehen und bis 500 Kilos tragen.
- Vielseitig und kompakt.
- Enger Wendekreis.
- Mit pneumatischen Rädern für den Innen- und Außenbereich.
- Knopf zur Einstellung der Geschwindigkeit in 5 Stufen.
- Große Auswahl an Standardzubehör oder auf Anfrage anpassbar.

👁 **Vorderansicht**



👁 **Seitenansicht**



👁 **Rückansicht**



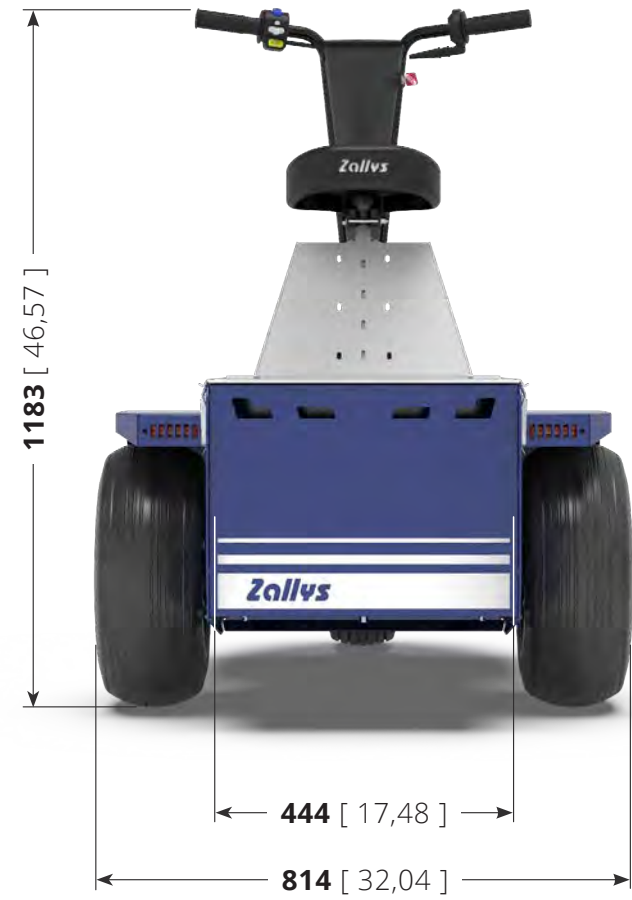
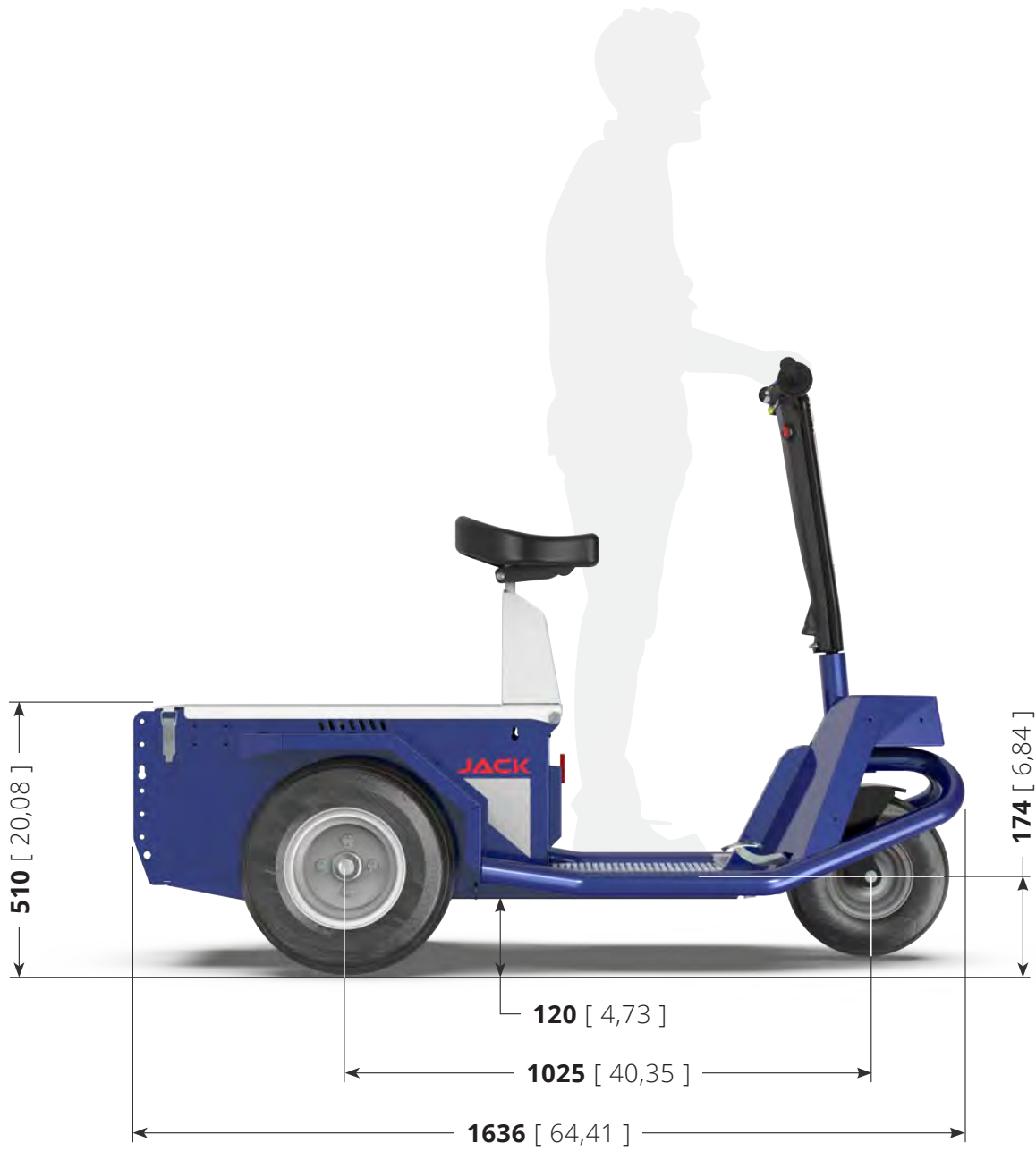

	TABLE: Z121.732	JACK	Unit: mm [inch]
--	---------------------------	-------------	-----------------

Hauptsektoren



AUTOMOBILINDUSTRIE



GLASINDUSTRIE



FERTIGUNGSLINIEN



FERTIGUNGSLINIEN



INDUSTRIEWARTUNG





FLUGHÄFEN

Leistungen auf Gefälle

Bei unveränderter Hakenkraft in N können die Zugkraft in kg und das Gewicht der zu **befördernden Ladung je nach:**

- **Boden-Typologie;**
- Schleppnetz auf ebenem **oder geneigtem Boden;**
- Verwendung oder Nichtverwendung **von Ballast;**
- Räder Typologie der **Maschine oder des Wagens.**

 = Standardversion
 = Mit Upgrade

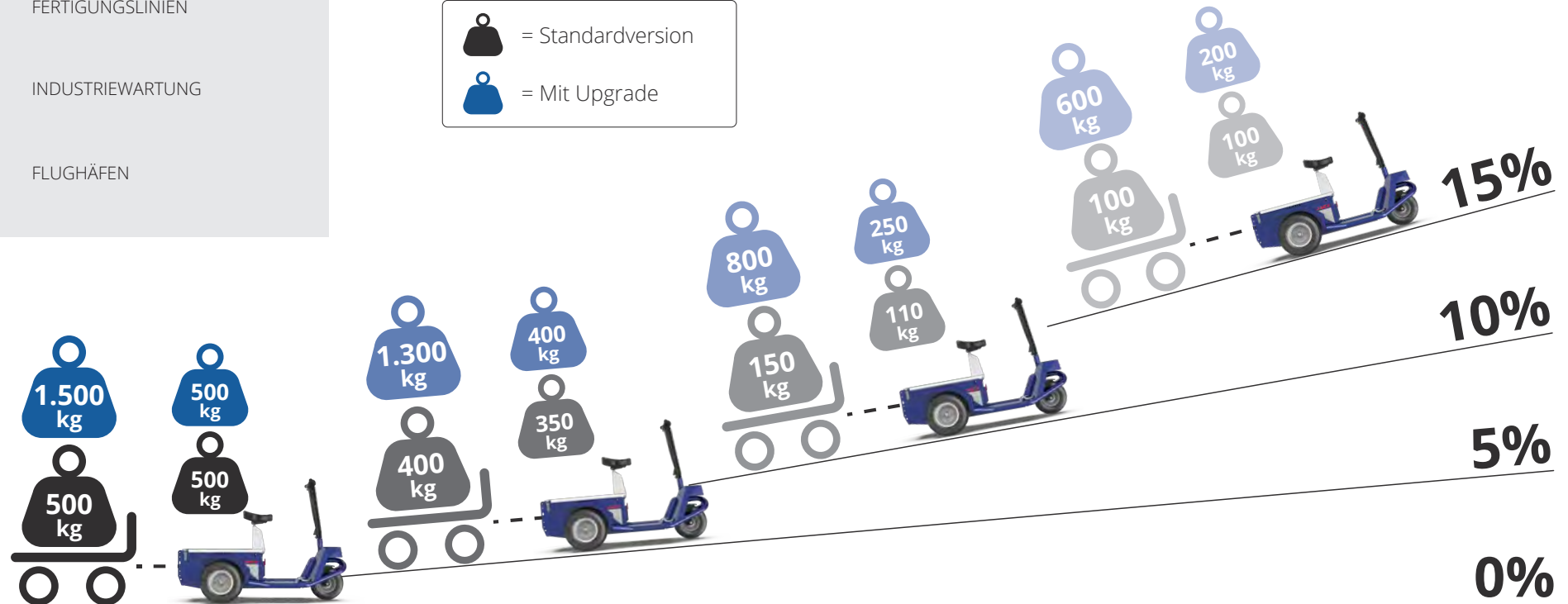

Ergonomische Führung

Der JACK Lenker wurde entwickelt, um die Verwendung der Maschine für den Bediener auch bei längerem Gebrauch ergonomischer zu gestalten. Alle Bedienelemente sind in Reichweite; die verbleibende Batterieladung und die Fahrtrichtung sind auf dem LED-Display immer sichtbar. **Der Schlüssel ist auf der rechten Seite für eine schnelle und bequeme Zündung.** Die Struktur besteht aus widerstandsfähigen Materialien bei versehentlichen Stößen.

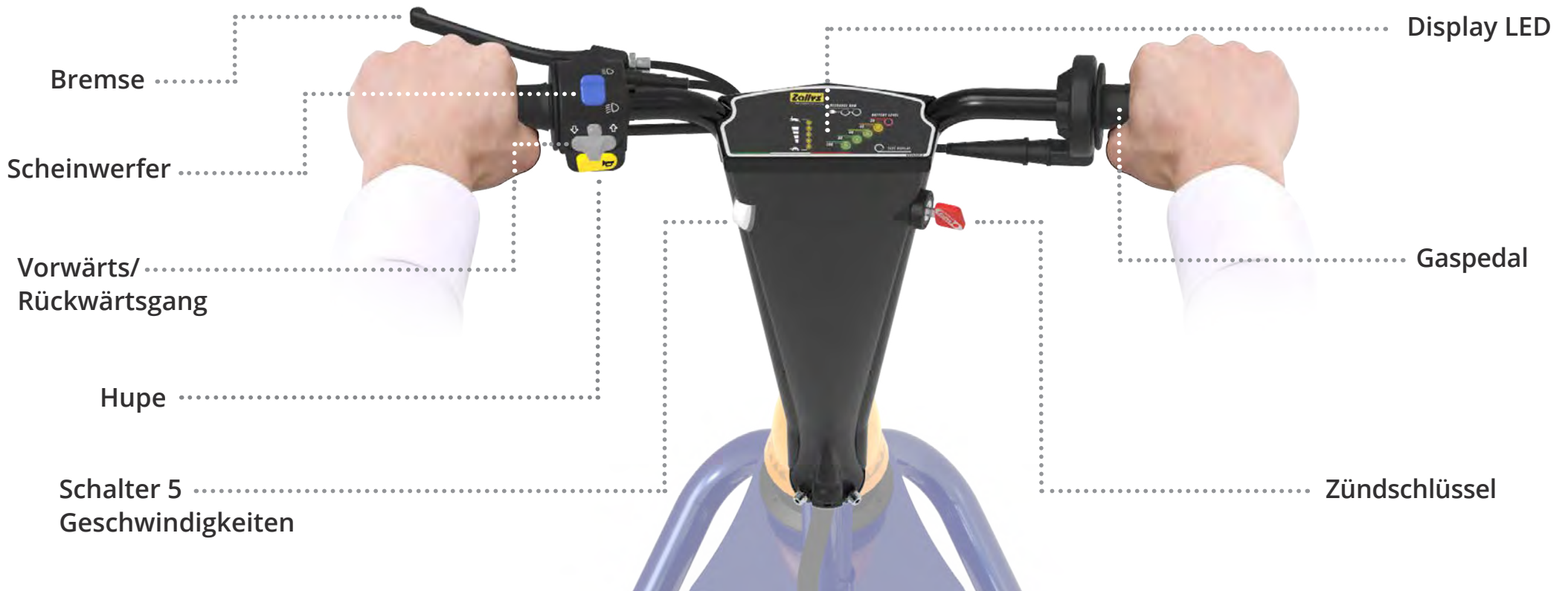

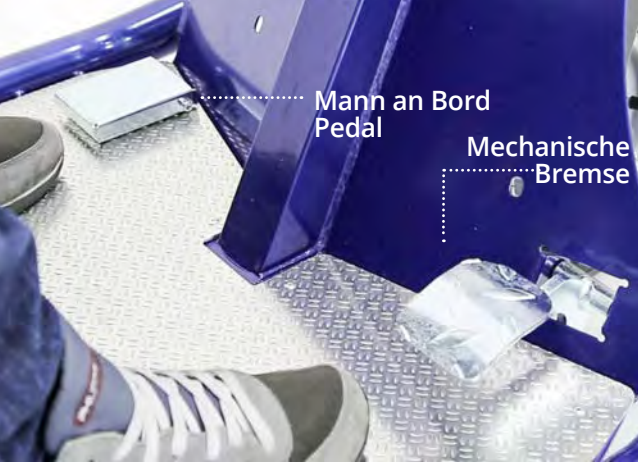

Maximale Sicherheit

Auf der **Jack** Plattform sind zwei Pedale vorhanden, um maximale Betriebssicherheit zu gewährleisten. pedale uomo presente: - **Mann an Bord Pedal:** wird das Pedal nicht betätigt, sind die Bedienungseinrichtungen des Fahrers außer Betrieb, um plötzliche und potenziell gefährliche Bewegungen zu vermeiden, wenn die Maschine nicht in Betrieb ist. - **Mechanische Bremse zum Anhalten der Maschine im Notfall.**



Reichweite für einen ganzen Arbeitstag

Der **Jack** wird mit 2 AGM 105/130Ah Batterien betrieben. Sie garantieren der Maschine eine **Autonomie von 8 Arbeitsstunden bei Dauereinsatz.** Beim Upgrade werden stattdessen vier 200 / 240 Ah-Batterien verbaut, um die gleiche Lebensdauer auch bei höherer Leistung zu gewährleisten. Dank des externen Hochfrequenz Ladegerät, sind die Batterien einfach und sicher aufzuladen.



Die richtigen Räder für jeden Bedarf

JACK montiert serienmäßig **pneumatische Räder**, die vorwiegend für den Außen und Innen Einsatz geeignet sind, ideal auf schlammigen oder unverbundenen Böden, um stets maximale Bodenhaftung und sehr geringe Vibrationen zu gewährleisten. Darüber hinaus sind sie sehr widerstandsfähig und bieten außergewöhnliche Leistung auf jedem Gelände. Auf Wunsch können auch andere Gummierungstypen montiert werden, z.B. Traktorräder für unebenes Gelände oder **«superelastische Non-marking»-Vollräder** für empfindliche Böden.

STANDARD HAKEN

JACK bietet eine große Auswahl an Zubehör, um immer die perfekte Maschine nach Kundenwunsch konfigurieren zu können, wie zum Beispiel Körbe in verschiedenen Größen für den Materialtransport, verschiedene Arten von Schlepphaken und Zubehör zur Erhöhung der Sicherheit, **wie blinkende Kreisel und Schutzgehäuse.**



ZÜBEHORTEILE

Sichtbarkeit in jeder Umgebung

JACK ist serienmäßig mit **Vordern und Hinter -LED leuchten** ausgestattet, um auch in Umgebungen zu fahren, in denen nicht immer eine ausreichende Beleuchtung gewährleistet ist, und mit einem vorderen Kreisel, der die Position signalisiert.



ZÜBEHORTEILE

Maximale Agilität für eine effizientere Nutzung

Die **JACK** Plattform ist in einer Mindesthöhe über dem Boden positioniert, um das schnelle und sichere Ein- und Aussteigen aus dem Fahrzeug zu ermöglichen, **die Arbeitszeiten zu verkürzen** und die **Produktivität zu steigern**. Es ist auch möglich, anstelle des Sattels eine bequeme **ergonomische Rückenlehne** anzubringen, um die Ermüdung bei längeren Fahrten zu verringern.

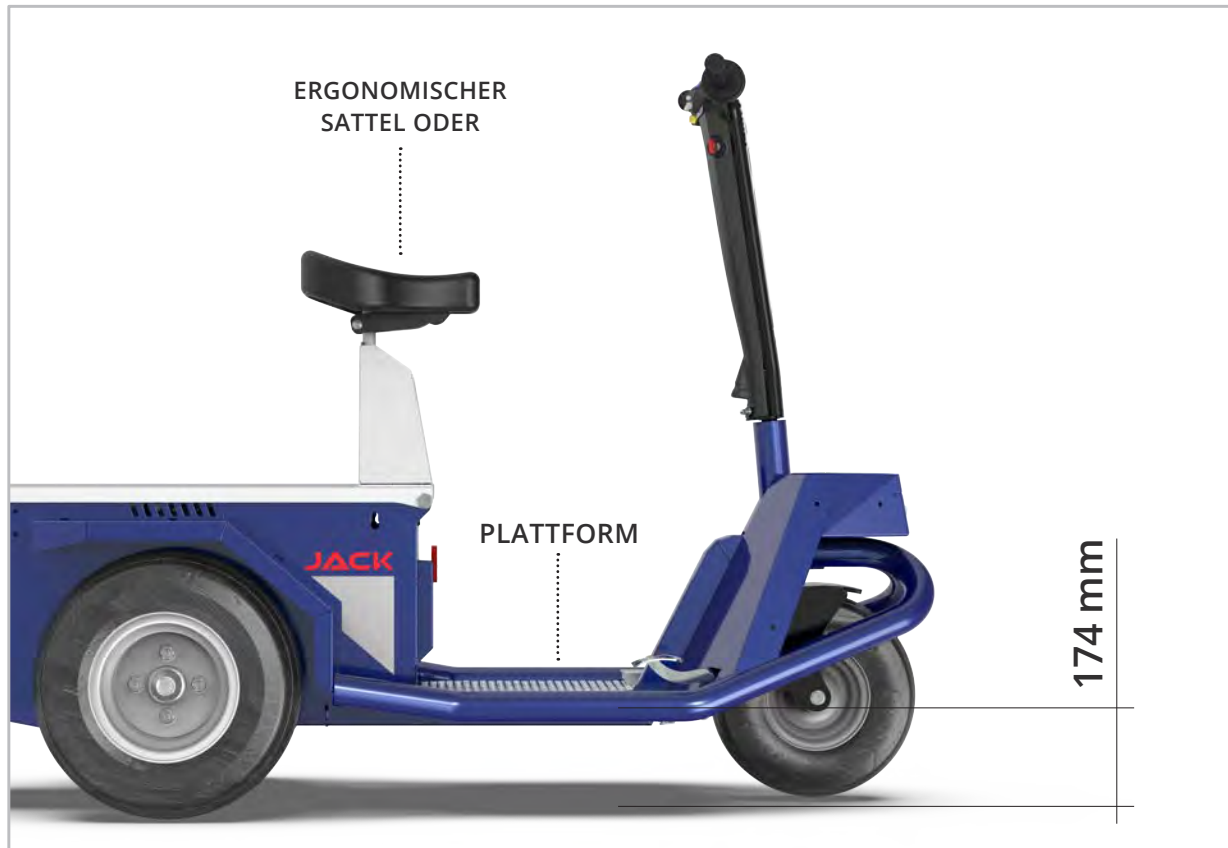



Anwendungsbeispiele

in den verschiedenen Produktionssektoren



INDUSTRIEWARTUNG

Zollys
the passion for moving







FLUGHÄFEN

Zallys
... the passion for moving





TEXTILINDUSTRIE

Zollis
... the passion for moving





ABFALLBEHANDLUNG

Zollis
... the passion for moving





GRÜNFLÄCHENAMT

Zollys
... the passion for moving





BESONDERE ANWENDUNGEN

Zollis
... the passion for moving



Zollis CE
www.zollis.com
131112



• • • the passion for moving

Zallys srl srl - Via Palazzina 1, Sarcedo
36030 (VI) - Italia

Contacts:

sales@zallys.com
+39 0445 366785

Web site:

www.zallys.com



The word "JACK" is printed in a large, bold, red, sans-serif font on a blue, metallic-looking surface. The letters are slightly shadowed, giving them a three-dimensional appearance. The background is a close-up of a blue metal structure, possibly part of a truck or trailer, with some rivets and a black rectangular component visible.